

CONTENTS

OEM

- 02 **Cable Housing**
- 20 **Inner Cable**
- 26 **Bmx Free Style**
- 27 **Brake Shoes**
- 28 **Disc Pads**
- 29 **Parts Series**

AFTERMARKET

- 54 **Cable Set**
- 66 **Pet Blister**
- 70 **Box**
- 74 **Lube**
- 78 **Box-Inner**
- 80 **Nips**
- 82 **Bmx Free Style**
- 83 **Brake Shoes**
- 84 **Disc Pads**
- 84 **HYDRAULIC HOUSING REPLACEMENT TOOL KIT**
- 85 **Hydraulic Cutter**
- 85 **Cable / Housing Cutter**
- 86 **Combo**
- 89 **Lock**

CABLE HOUSING



Friction

"How to reducing friction force" has always been the concern to our team, this issue becomes important especially when nowadays more and more bicycles using Internally Routed Bike Frame and need low friction housings.

So now all the housings we produce are fully upgraded to pre-lubricated with oil type.

Users do not need to worry about whether it is pre-lubricated or not when selecting products, users will just have the best smoothness housing products.

“降低摩擦力”一直是我們團隊關心的問題，這個訴求變得極為重要因為現在越來越多的自行車使用內埋式走線車架需要低摩擦力管線產品。因此，現在我們生產的所有外管都已完全升級為預油潤滑。用戶在選擇產品時無需擔心是否有預先潤滑的問題，用戶將擁有最佳光滑度的外管產品。

The Advantages of Using Grease

- Better performance on lower friction.
- Semi-solid state, does not dripping.
- High temperature / low temperature resistance, Low volatility and better waterproof.
- Longer service life than the liquid oil.

採用半固態油具有以下更多優點

- 更好的低摩擦力值表現
- 呈凝固狀態，不易滴落
- 耐高溫、耐低溫、揮發性低、防水性較佳
- 較一般液態油使用壽命更長



Housing for Internally Routed Bike and
Dropper Seat Post

Lightweight Products

內埋式變速外管與伸縮座管用外管
輕量化產品

The Internally Routed bike design is becoming the mainstream of future bicycles. Which not only makes the appearance of bicycles simple and neat, but also can reduce wind resistance.

The difficult part of this design is it requires making housing get inside and go through the frame, which often brings lots difficulty to the riders.

We improved the structure and design of our housings, managed to reduce the hardness, make the housing softer, and increase the strength of it.

So now riders can easily make housing routing through the frame, problem solved!

內埋式走線設計將成為未來自行車主流，不但讓車子外觀簡潔俐落，又可以達到降低風阻功效，但是受限於此設計，管線必須穿入車架內，常常帶給組車者非常大的困擾。我們改良了外管結構與設計，降低了外管的硬度，使其變得更柔軟，又增加了外管的強度，讓組車者能輕鬆穿入車架內，解決內埋式走線所帶來問題！



SSH

OD 4mm Housing
50% strength increased
Shapeable designed housing specially for Internally Routed Bike
30% less weight compared with regular shifter housing

外徑 4mm 變速外管
增加強度 50%
屬於定型結構，易用於內埋車架用
比較一般變速外管，重量降低 30%

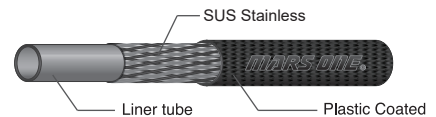

CSH-TO

OD 4mm Housing for Internally Routed Bike and Dropper Seat Post
Multiple strands of steel string layer makes the structure softer
Low friction

外徑 4mm 變速與伸縮座外管
多股數鋼絲層，使得結構更柔軟
低摩擦係數

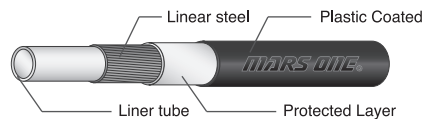

| ITEN NO. | COLOR |
|----------|--------------------|
| C1 | Black 黑色 |
| C2 | White 白色 |
| C3 | SHIMANO Gray 灰色 |
| C4 | Red 紅色 |
| C5 | Blue 藍色 |
| C6 | Green 綠色 |
| C7 | Pink 粉紅色 |
| C8 | Orange 橘色 |
| C9 | Yellow 黃色 |

| ITEN NO. | COLOR |
|----------|---------------------|
| C10 | Pearl Silver 珍珠銀 |
| C11 | Brown 咖啡色 |
| C12 | Grape 葡萄色 |
| C13 | Earth 土色 |
| C14 | Purple 紫色 |
| C15 | Lake Blue 湖水藍 |
| C16 | Grass Green 草綠色 |
| C17 | Light Pink 粉紅色 |
| C18 | Orange 亮橘色 |

| ITEN NO. | COLOR |
|----------|-----------------------|
| C19 | Yellow 黃色 |
| C20 | Peach 桃紅色 |
| C21 | Oilve 深綠色 |
| C22 | Sky Blue 天空藍 |
| C23 | Purplish Blue 深紫藍色 |
| C24 | Cappuccino 卡布奇諾 |
| C25 | Gold 金色 |
| C26 | Silver 銀 |

CABLE HOUSING

BASIC SERIES

基本系列

» Derailleur Cable Housing 變速外管

CSH

Suitable for OD: 4mm, 5mm
Low friction
Ultimate sensitiveness
Light weight for liner shell

適用於外徑 4mm, 5mm 外管
低摩擦係數
極佳靈敏度
直絲結構重量較輕

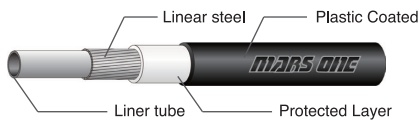

CIH

Suitable for OD: 4mm
High plasticity
Liner tube for MOS2 could increase shifting efficiency

適用於外徑 4mm 外管
高可塑性
內管添入 MOS2(二硫化鉬) 增加潤滑效果，提升變速靈敏度

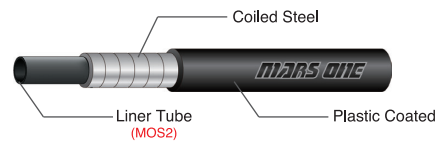

» Brake Cable Housing 煞車外管

CPH

Suitable for OD: 5mm
High pressure-resistance force
Low friction
High plasticity
Plastic coated could choose cold-resistant material

適用於外徑 5mm 外管
高耐壓強度
低摩擦阻力
高可塑性
批覆層可選擇耐寒塑膠材質

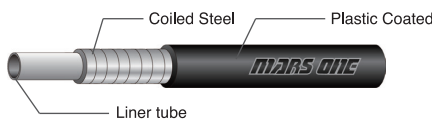

CMH

Suitable for OD: 5mm
Low friction
High plasticity
Liner tube for MoS2 could increase brake efficiency

適用於外徑 5mm 外管
低摩擦阻力
高可塑性
內管添入 MoS2 (二硫化鉬) 增加潤滑效果，提升煞車靈敏度

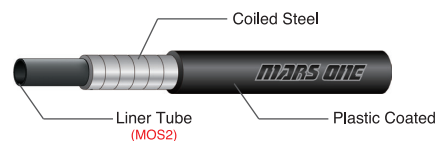

| ITEM NO. | COLOR | |
|----------|--------------------|--|
| C1 | Black 黑色 | |
| C2 | White 白色 | |
| C3 | SHIMANO Gray 灰色 | |
| C4 | Red 紅色 | |
| C5 | Blue 藍色 | |
| C6 | Green 綠色 | |
| C7 | Pink 粉紅色 | |
| C8 | Orange 橘色 | |
| C9 | Yellow 黃色 | |

| ITEM NO. | COLOR | |
|----------|---------------------|--|
| C10 | Pearl Silver 珍珠銀 | |
| C11 | Brown 咖啡色 | |
| C12 | Grape 葡萄色 | |
| C13 | Earth 土色 | |
| C14 | Purple 紫色 | |
| C15 | Lake Blue 湖水藍 | |
| C16 | Grass Green 草綠色 | |
| C17 | Light Pink 粉紅色 | |
| C18 | Orange 亮橘色 | |

| ITEM NO. | COLOR | |
|----------|-----------------------|--|
| C19 | Yellow 黃色 | |
| C20 | Peach 桃紅色 | |
| C21 | Oilve 深綠色 | |
| C22 | Sky Blue 天空藍 | |
| C23 | Purplish Blue 深紫藍色 | |
| C24 | Cappuccino 卡布奇諾 | |
| C25 | Gold 金色 | |
| C26 | Silver 銀 | |

NEW HOUSING COATING MATERIAL

Traditional coiled steel housing is coated by PVC plastic. To meet the EU's future Restriction on limiting using PVC, We developed a new plastic composite material for Coiled steel housing.

The new coating material also provides a better performance on compression test.

傳統捲圓鋼鐵層型態的外管均使用 PVC 塑料來做包覆。但為配合歐盟未來的 PVC 塑膠禁限用限制，我們研發出新的塑膠複合材料用於外管包覆。

同時也提供更佳的外管壓縮量質表現

» Derailleur Cable Housing 變速外管

FIH

OD 4mm housing, coiled steel layer
New composite can reduce weight down about 6%
Low friction
High plasticity
Optimized toughness. Better performance on compression test

4mm 外徑外管，捲圓鋼鐵層結構
複合式塑料降低 6% 重量
低摩擦力
高可塑性
優化韌性與強度，外管壓縮比測試數值更佳



» Brake Cable Housing 煞車外管

FPH

OD 5mm housing, coiled steel layer
New composite can reduce weight down to 6%
High pressure-resistance force
Low friction
High plasticity
Optimized toughness. Better performance on compression test

5mm 外徑外管，捲圓鋼鐵層結構
複合式塑料降低 6% 重量
高耐壓強度
低摩擦力
高可塑性
優化韌性與強度，外管壓縮比測試數值更佳



| ITEN NO. | COLOR |
|----------|--------------------|
| C1 | Black 黑色 |
| C2 | White 白色 |
| C3 | SHIMANO Gray 灰色 |
| C4 | Red 紅色 |
| C5 | Blue 藍色 |
| C6 | Green 綠色 |
| C7 | Pink 粉紅色 |
| C8 | Orange 橘色 |
| C9 | Yellow 黃色 |

| ITEN NO. | COLOR |
|----------|---------------------|
| C10 | Pearl Silver 珍珠銀 |
| C11 | Brown 咖啡色 |
| C12 | Grape 葡萄色 |
| C13 | Earth 土色 |
| C14 | Purple 紫色 |
| C15 | Lake Blue 湖水藍 |
| C16 | Grass Green 草綠色 |
| C17 | Light Pink 粉紅色 |
| C18 | Orange 亮橘色 |

| ITEN NO. | COLOR |
|----------|-----------------------|
| C19 | Yellow 黃色 |
| C20 | Peach 桃紅色 |
| C21 | Oilve 深綠色 |
| C22 | Sky Blue 天空藍 |
| C23 | Purplish Blue 深紫藍色 |
| C24 | Cappuccino 卡布奇諾 |
| C25 | Gold 金色 |
| C26 | Silver 銀 |

The background features a complex, abstract composition of thick, glowing lines in various colors including blue, green, red, yellow, and purple. These lines are arranged in a crisscrossing pattern, creating a sense of depth and movement. The lines have a soft, ethereal glow and are set against a dark, almost black background. In the top right and bottom left corners, there are large, solid red geometric shapes that appear to be overlapping the other elements.

FLUORESCENT

Available special color option 適用特殊色

LASERS 雷射

| ITEN NO. | COLOR |
|----------|-------|
| LCH001 | |
| LCH002 | |
| LCH003 | |
| LCH004 | |
| LCH005 | |
| LCH006 | |
| LCH007 | |
| LCH008 | |
| LCH009 | |
| LCH010 | |
| LCH011 | |

LAMINATING 貼合

| ITEN NO. | COLOR |
|----------|-------|
| CCH001 | |
| CCH002 | |
| CCH003 | |
| CCH004 | |
| OCH003 | |
| OCH004 | |
| OCH005 | |
| OCH006 | |
| OCH007 | |

TRANSPARENT 透明

| ITEN NO. | COLOR |
|----------|-------|
| TCH001 | |
| TCH002 | |
| TCH003 | |
| TCH004 | |
| TCH005 | |

Available only for Brake 適用於煞車外管 **CPH** / Available only for Shifting 適用於變速外管 **CSH**

Fluorescent color has become trendy nowadays due to lots of frame design are playing light, lively color. To meet the market need. We have improved our full line neon color. Except the brighter color presentation. The new neon color compound has passed SGS 140hrs UV-test. The beauty color tone stays for longer lifetime.

螢光色系正引領市場潮流，許多車架目前都採用此跳動的亮眼色系設計。為滿足市場上對螢光色系的產品需求，我們推出了一系列的螢光色外管，且通過 SGS 奈黃變燈照測試，UV 測試結果突破 140hrs 可維持原本亮麗的顏色，提供客戶更長的产品壽命週期。

FLUORESCENT 螢光

| ITEN NO. | COLOR |
|----------|-------|
| FCH001 | |
| FCH002 | |
| FCH003 | |
| FCH004 | |
| FCH006 | |
| FCH007 | |
| FCH008 | |
| OCH009 | |

MATT SERIES 消光

| ITEN NO. | COLOR |
|----------|-------|
| MBK | |
| MGY | |
| MRD | |
| MBR | |
| MBU | |

Available only for Brake 適用於煞車外管 **FPH**
Available only for Shifting 適用於變速外管 **CSH**

CABLE HOUSING

BRAIDED SERIES

/ 編織系列

» Derailleur Cable Housing 變速外管

BSH

Suitable for OD: 4.5mm
Reinforces derailleur performance and Reception

適用於外徑 4.5mm 外管
增加強力紗編織層可強化產品效能

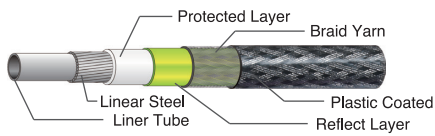

» Brake Cable Housing 煞車外管

BPH

Suitable for OD:5mm
Reflect layer make brake system feel High-class.
Reinforces brake performance and Reception by special steel and polyester yarn.

適用於外徑 5mm 外管
編織反射層增添煞車系統亮眼質感
特殊鋼料層級聚脂纖維紗強化煞車效能

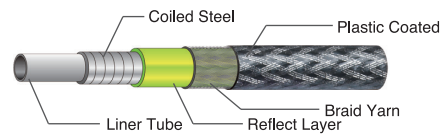

| ITEN NO. | COLOR |
|----------|-----------------------|
| D1 | Braided Black 編織黑 |
| D2 | Braided Silver 編織銀 |
| D3 | Braided Gold 編織金 |

REINFORCED SERIES

/ 強化系列 (BMX)

» Brake Cable Housing 煞車外管

RPH

Suitable for brake system OD: 5mm
Stainless steel weaving improves Pressure resistance.
Staple fiber structure provides better braking performance and longer life of housing.
Better lubrication if provided with oil injection.

適用於外徑 5mm 煞車外管
使用不鏽鋼的編織層，提升抗壓強度
直絲結構提供較佳的煞車效能和延長的導管壽命
搭配注油效果，潤滑度更佳

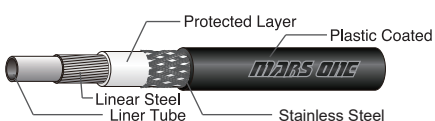

| ITEN NO. | COLOR |
|----------|--------------------------|
| R1 | Transparent Black 透明黑 |
| R2 | Black 黑色 |
| R3 | White 白色 |
| R4 | Red 紅色 |
| R5 | Green 綠色 |
| R6 | Orange 橘色 |
| R7 | Yellow 黃色 |
| R8 | Blue 藍色 |
| R9 | Pink 粉紅色 |

KEVLAR SERIES / 克維拉系列

» **Derailleur Cable Housing**
變速外管

KSH

Suitable for derailleur system OD: 4mm
High chemical Resistance
Low elongation at break
Bears the impact

適用於外徑 4mm 外管
高抗拉
低延伸率
耐衝擊

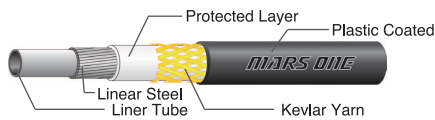

» **Brake Cable Housing**
煞車外管

KBH

Suitable for brake system OD: 5mm
Light weight 25% less than common Brake cable housing.
High chemical Resistance
Low elongation at break
Bears the impact

適用於外徑 5mm 外管
比一般的煞車外管材質輕量化 25%
高抗拉
低延伸率
耐衝擊

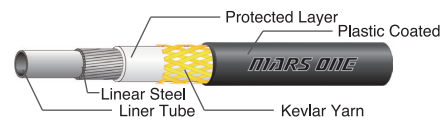

| ITEN NO. | COLOR |
|-----------|----------------------|
| K1 | Kevlar Black 克維拉黑 |
| K2 | Kevlar White 克維拉白 |
| K3 | Kevlar Gray 克維拉灰 |
| K4 | Kevlar Red 克維拉紅 |
| K5 | Kevlar Blue 克維拉藍 |

| ITEN NO. | COLOR |
|------------|-----------------------|
| K6 | Kevlar Green 克維拉綠 |
| K7 | Kevlar Pink 克維拉粉紅 |
| K8 | Kevlar Orange 克維拉橘 |
| K9 | Kevlar Yellow 克維拉黃 |
| K10 | Kevlar Silver 克維拉銀 |

| ITEN NO. | COLOR |
|------------|---------------------------------|
| K11 | Fluorescent Green 螢光綠 |
| K12 | Fluorescent Yellow 螢光黃 |
| K13 | Fluorescent Red 螢光紅 |
| K14 | Fluorescent Orange 螢光橘 |
| K15 | Fluorescent Dark Blue 螢光深藍 |
| K16 | Fluorescent Light Blue 螢光淺藍 |
| K17 | Fluorescent Light Green 螢光淺綠 |

CARGO-KBH

6mm housing can pair with 2.0mm inner cable
11mm housing can pair with 4.0mm inner cable
Linear steel string structure provides good conduction when steering
Kevlar braided layer can withstand the compression force when making a turn

6mm 外管外徑 搭配 2.0mm 內線
11mm 外管外徑 搭配 4.0mm 內線
直絲結構提供良好的轉向傳導特性
克維拉強化編織層能承受轉向時所帶來的壓縮比

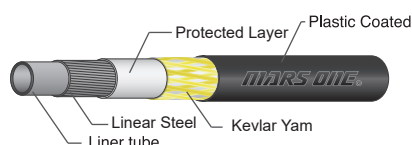

Cargo Bike 用旋轉系統外管
Special Housings for Cargo Bike Steering system

| ITEN NO. | COLOR |
|------------|------------------------------------|
| CK1 | Kevlar Transparent Black 克維拉透明黑 |
| CK2 | Kevlar Black 克維拉黑 |

CABLE HOUSING

HYDRAULIC SERIES / 油壓管系列

HPN

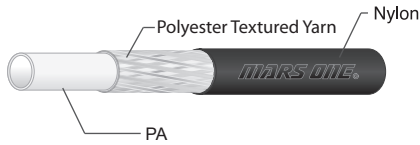

| ITEN NO. | COLOR |
|----------|-------------|
| HK01 | Black 黑色 |
| HK02 | White 白色 |
| HK03 | Red 紅色 |
| HK04 | Blue 藍色 |

| ITEN NO. | COLOR |
|----------|--------------|
| HK05 | Green 綠色 |
| HK06 | Pink 粉紅色 |
| HK07 | Orange 橘色 |
| HK08 | Yellow 黃色 |

HKN

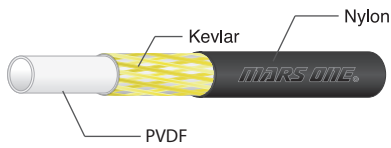

| ITEN NO. | COLOR |
|----------|-------------|
| HK01 | Black 黑色 |
| HK02 | White 白色 |
| HK03 | Red 紅色 |
| HK04 | Blue 藍色 |

| ITEN NO. | COLOR |
|----------|--------------|
| HK05 | Green 綠色 |
| HK06 | Pink 粉紅色 |
| HK07 | Orange 橘色 |
| HK08 | Yellow 黃色 |

HSN

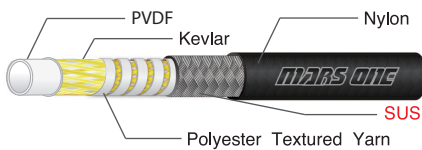

| ITEN NO. | COLOR |
|----------|---------------------------|
| HS01 | Transparent Black 透明黑 |
| HS02 | Transparent Silver 透明銀 |



CABLE HOUSING

HYDRAULIC ACCESSORIES / 油壓管配件

SHIMANO, FORMULA ID:2.3 OD:5.0

HA1

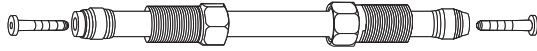

COMPATIBLE MODEL

SHIMANO:

XTR 2007~2010
DEORE XT 2008~2011
DEORE 2005~2011
SLX 2009~2011
DEORE LX 2005~2011
HONE M535

XTR M975
DEROE T615, M595, M535, M525
ALiViO M4050
DEORE M6000, M596, M615
DEORE LX T675

HA2

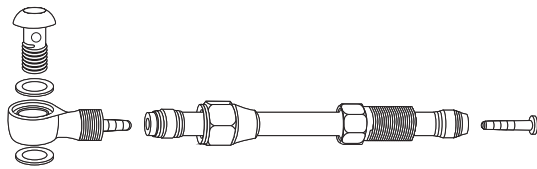

COMPATIBLE MODEL

SHIMANO:

DEORE XT 2005~2007
SAINT M810
XTR 2011

HS1

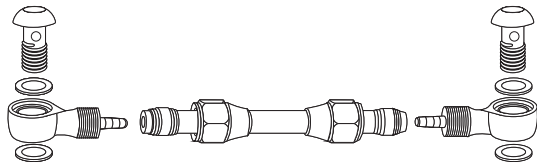

COMPATIBLE MODEL

FORMULA: ORO

SHIMANO: XTR 2005~2006

» OEM PARTS

| ITEM NO. | PRODUCT | STRUCTURE | MATERIAL | PACKAGE |
|--------------|---------|-----------|-----------------|---------|
| HBE-260830ST | | | Stainless 白鐵 | 100/BOT |
| HBE-260830AL | | | Alloy 鋁 | 100/BOT |
| HBE-260626ST | | | Stainless 白鐵 | 100/BOT |
| HCS-081152ST | | | Stainless 白鐵 | 100/BOT |
| HCN-101252ST | | | Stainless 白鐵 | 100/BOT |
| HCN-101252AL | | | Alloy 鋁 | 100/BOT |
| HCA-081652AL | | | Alloy 鋁 | 100/BOT |
| HIN-110526BR | | | Brass 銅 | 800/BOT |
| HCB-070652BR | | | Brass 銅 | 300/BOT |

» OEM PARTS

| ITEN NO. | PRODUCT | STRUCTURE | MATERIAL | PACKAGE |
|----------------|----------|-----------|-----------------|---------|
| HIN-110526ST | FOR BH90 | | Stainless 白鐵 | 800/BOT |
| HIN-130526BR | FOR BH59 | | Brass 銅 | 800/BOT |
| HCB-070652BR-1 | FOR BH59 | | Brass 銅 | 300/BOT |
| HCB-070652AL | | | Alloy 鋁 | 300/BOT |

HA1



HA2



HS1



» AFTERMARKET PARTS

| ITEN NO. | PRODUCT | STRUCTURE | MATERIAL | PACKAGE |
|--------------|---------|-----------|-----------------|---------|
| HIN-130726BR | | | Brass 銅 | 200/BOT |
| HBE-950827ST | | | Stainless 白鐵 | 50/BOT |
| HBN-1025M6ST | | | Stainless 白鐵 | 50/BOT |
| HSS-1115M6ST | | | Stainless 白鐵 | 200/BOT |
| HSS-1115M6IR | | | Iron 鐵 | 200/BOT |
| HCP-073011BK | | | Plastic 塑膠 | 40/BOT |
| HCP-102211BK | | | Plastic 塑膠 | 50/BOT |

CABLE HOUSING

HYDRAULIC ACCESSORIES

/ OEM 油壓管附件

/// HAYES, TEKTRO ID:2.5 OD:5.4

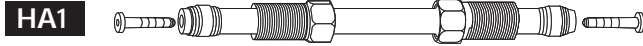

HA1

COMPATIBLE MODEL

HAYES:
STROKER RYDE
DYNO SPORT
RADAR
PRIME SPORT

TEKTRO:
AURIGA COMP WS
DRACO WS
GEMINI

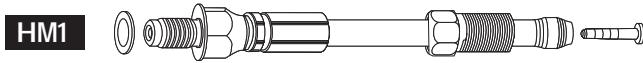

HM1

COMPATIBLE MODEL

HAYES:
NINE

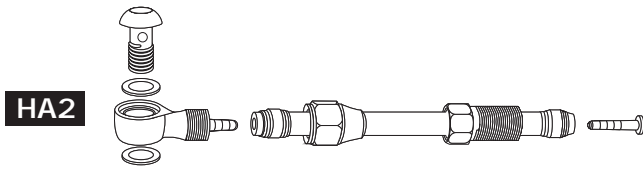

HA2

COMPATIBLE MODEL

HAYES:
PRIME EXPERT, PRO, COMP
STROKER, TRAIL CARBON, ACE

TEKTRO:
GEMINI SL
VOLANS.
DASH CARBON, DASH SPORT

» OEM PARTS

| ITEN NO. | PRODUCT | STRUCTURE | MATERIAL | PACKAGE |
|----------------|---------|-----------|-----------------|---------|
| HBE-280830ST | | | Stainless 白鐵 | 100/BOT |
| HBE-280830AL | | | Alloy 鋁 | 100/BOT |
| HCN-101257ST | | | Stainless 白鐵 | 100/BOT |
| HCN-101257AL | | | Alloy 鋁 | 100/BOT |
| HCS-081157ST | | | Stainless 白鐵 | 100/BOT |
| HBN-1032M6ST28 | | | Stainless 白鐵 | 100/BOT |
| HCA-081657AL | | | Alloy 鋁 | 100/BOT |
| HIN-110528BR | | | Brass 銅 | 800/BOT |
| HCB-070657BR | | | Brass 銅 | 300/BOT |
| HCB-070657AL | | | Alloy 鋁 | 300/BOT |

HA1













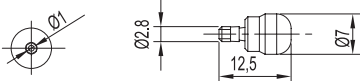

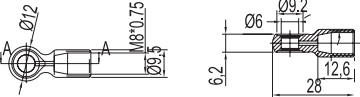
HM1

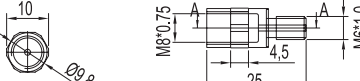

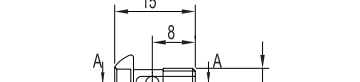
HA2

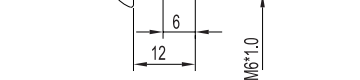

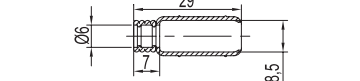
» AFTERMARKET PARTS

| ITEN NO. | PRODUCT | STRUCTURE | MATERIAL | PACKAGE |
|--------------|---|--|-----------------|---------|
| HIN-130728BR |  |  | Brass 銅 | 200/BOT |
| HBE-950827ST |  |  | Stainless 白鐵 | 50/BOT |
| HBN-1025M6ST |  |  | Stainless 白鐵 | 50/BOT |
| HSS-1115M6ST |  |  | Stainless 白鐵 | 200/BOT |
| HSS-1115M6IR |  |  | Iron 鐵 | 200/BOT |
| HCP-073011BK |  |  | Plastic 塑膠 | 40/BOT |
| HCP-102211BK |  |  | Plastic 塑膠 | 50/BOT |

CABLE HOUSING

HYDRAULIC ACCESSORIES

/ OEM 油壓管附件

SRAM, MAGURA ID:2.1 OD:5.0

HA1

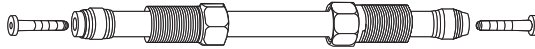

COMPATIBLE MODEL

SRAM:

JUICY 3
CODE COD 2008~2010,

5,7R, 2001,2017
GUILD RE

HM1

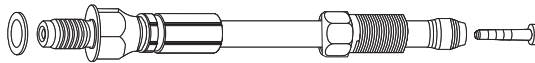

COMPATIBLE MODEL

MAGURA:

GLARA 2000~2002, LOUILS FR 2002~2006
GUSTAR 2000~2011, MARTA FR 2003~2010,
JULIE HP 2009~2010, MARTA 2002~2010,
LOUILS BAT 2008~2010, MARTA GOLD 2007,
LOUILS CARBOM 2008~2010,
MARTA SL 2003~2010, LOUILS 2000~2010

SRAM:

GUIDE RSC(A1), GUIDE RS(A1)
ELIXIR CR, ELIXIR CR MAGNESIUM,
ELIXIR R, ELIXIR 9, ELIXIR 7, ELIXIR 5,
X0, X7, X9

HA2

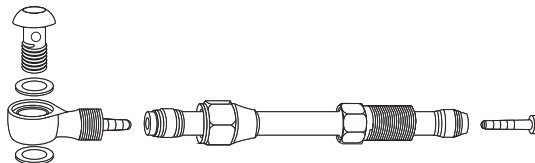

COMPATIBLE MODEL

SRAM:

XX WORLD CUP, XX, JUICY CROBON,
JUICY 7, JUICY 5, JUICY ULTIMATE7,
JUICY ULTIMATE







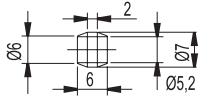

MAGULA:

GUSTAR M2000~2010,
MARTA GOLD 2007,
MARTA SL 2008~2010

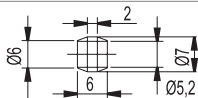

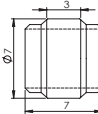







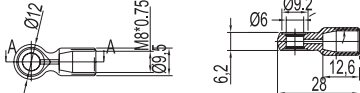

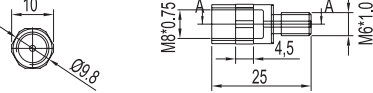

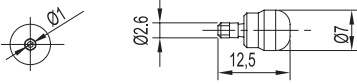

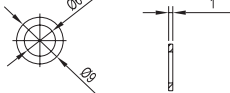

» OEM PARTS

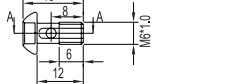
| ITEN NO. | PRODUCT | STRUCTURE | MATERIAL | PACKAGE |
|----------------|---------|-----------|-----------------|---------|
| HBE-240830ST | | | Stainless 白鐵 | 100/BOT |
| HBE-240830AL | | | Alloy 鋁 | 100/BOT |
| HBE-240630ST | | | Stainless 白鐵 | 100/BOT |
| HCS-081152ST | | | Stainless 白鐵 | 100/BOT |
| HCN-101252ST | | | Stainless 白鐵 | 100/BOT |
| HCN-101252AL | | | Alloy 鋁 | 100/BOT |
| HBN-1032M6ST24 | | | Stainless 白鐵 | 100/BOT |
| HCA-081652AL | | | Alloy 鋁 | 100/BOT |
| HIN-110524BR | | | Brass 銅 | 800/BOT |

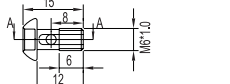
» OEM PARTS

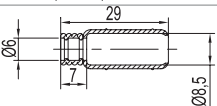
| ITEN NO. | PRODUCT | STRUCTURE | MATERIAL | PACKAGE |
|--------------|--|--|------------|---------|
| HCB-070652BR |  |  | Brass 銅 | 300/BOT |
| HCB-070652AL |  |  | Alloy 鋁 | 300/BOT |
| HCB-070752BR |  |  | Brass 銅 | 300/BOT |
| HA1 |  | | | |
| HM1 |  | | | |
| HA2 |  | | | |

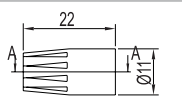
» AFTERMARKET PARTS

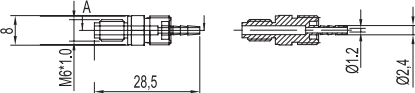
| ITEN NO. | PRODUCT | STRUCTURE | MATERIAL | PACKAGE |
|--------------|---|--|-----------------|---------|
| HBE-950827ST |  |  | Stainless 白鐵 | 50/BOT |
| HBN-1025M6ST |  |  | Stainless 白鐵 | 50/BOT |
| HIN-130724BR |  |  | Brass 銅 | 200/BOT |
| HOR-090106BR |  |  | Brass 銅 | 800/BOT |
| HOR-090106AL |  |  | Alloy 鋁 | 800/BOT |
| HSS-1115M6ST |  |  | Stainless 白鐵 | 200/BOT |
| HSS-1115M6IR |  |  | Iron 鐵 | 200/BOT |
| HCP-073011BK |  |  | Plastic 塑膠 | 40/BOT |
| HCP-102211BK |  |  | Plastic 塑膠 | 50/BOT |
| HBN-2429M6ST |  |  | Stainless 白鐵 | 100/BOT |

INNER CABLE

REGULAR TYPE

基本型

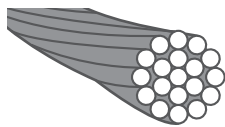
| PROJECT | DERAILLEUR | BRAKE | REINFORCED BRAKE | CARGO BIKE |
|---|--|-----------|------------------|------------|
| O.D / 線徑 | 1.2mm | 1.5mm | 1.6mm | 2.0mm |
| STRUCTURE / 結構 |  | | | |
| REGULAR GALVANIZED CABLE 基本鍍鋅內線名稱 | RGA | | | |
| REGULAR STAINLESS CABLE 基本白鐵內線名稱 | RST | | | |
| RGA THE MINIMUM TENSILE LOADING 基本鍍鋅內線 內部纜線的最小拉力負載 | 150Kg/ 公斤 | 255Kg/ 公斤 | 285Kg/ 公斤 | 430Kg/ 公斤 |
| RST THE MINIMUM TENSILE LOADING 基本白鐵內線 內部纜線的最小拉力負載 | 130Kg/ 公斤 | 215Kg/ 公斤 | 235Kg/ 公斤 | 380Kg/ 公斤 |

SLICK TYPE

研磨光滑型

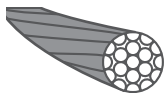
| PROJECT | DERAILLEUR | | BRAKE |
|--|---|-------|---|
| O.D / 線徑 | 1.1mm | 1.2mm | 1.5mm |
| STRUCTURE / 結構 |  | | |
| SLICK GALVANIZED CABLE SLICK 鍍鋅內線名稱 | SGA | | |
| SLICK STAINLESS CABLE SLICK 白鐵內線名稱 | SST | | |
| ADVANTAGE 優點 | <ul style="list-style-type: none"> - Suitable for galvanized steel wire and Stainless steel wire. - Wire cable will lower friction also smooth surface by slick. - Improved smoothness for brake and derailleur system. - Increase tension with safety. | | <ul style="list-style-type: none"> · 適用於鍍鋅及白鐵材質上 · 經過研磨處理後使得表面光滑、並能降低摩擦系數 · 能提升煞車系統與變速系統靈敏度 · 增加拉力提高安全性 |

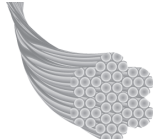
| PROJECT | BRAKE | |
|----------------------------|--|--|
| O.D / 線徑 | 1.5mm | |
| STRUCTURE / 結構 |  | |
| GALVANIZED CABLE 鍍鋅內線名稱 | DSG | |
| STAINLESS CABLE 白鐵內線名稱 | DST | |
| ADVANTAGE 優點 | <ul style="list-style-type: none"> - Lighter than standard type. - Reduce to the lowest friction. - Highly and great suppleness. - Service life longer than standard type. - Suitable for cable routing on bending and rounding parts while providing low friction effect. - Suit BMX the best. - Suit embedded cable routing the best. <ul style="list-style-type: none"> · 重量較輕 · 低摩擦 · 高柔軟 · 產品使用壽命比標準品高 · 適用於折彎處較多之組車走線，更能提供低摩擦效果 · BMX 車種使用佳 · 內埋式走線組車佳 | |

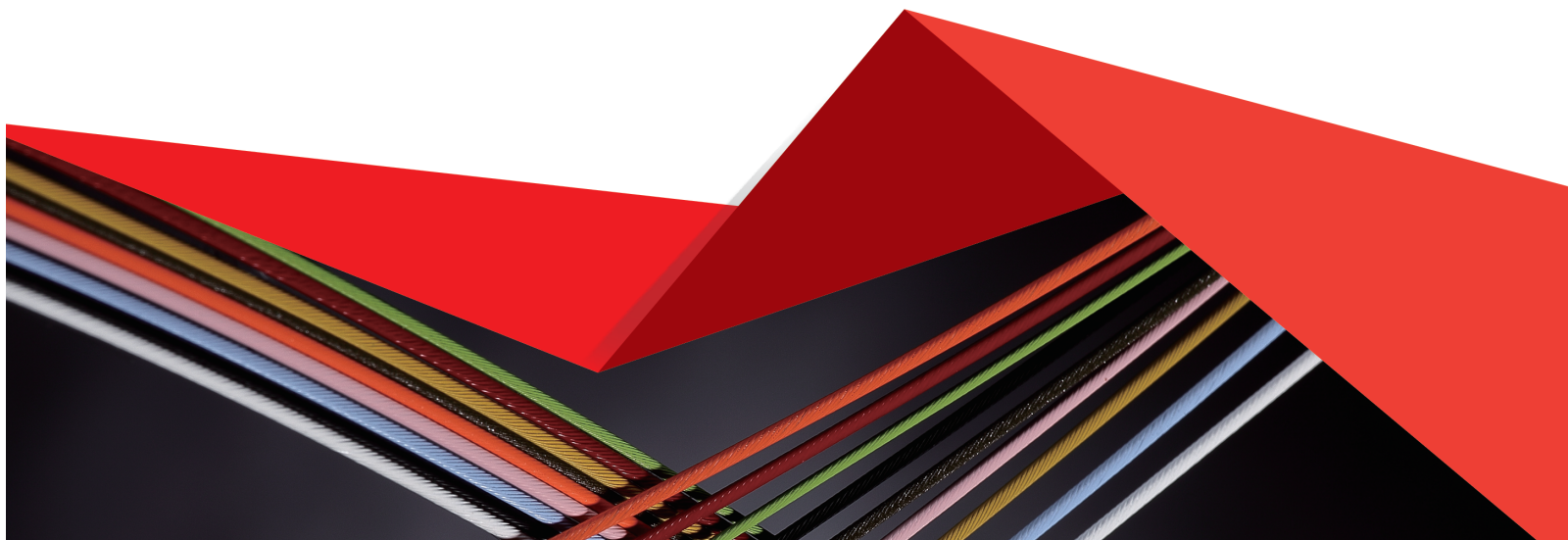

INNER CABLE

DOUBLE SLICK

／ 低摩擦研磨拋光

| PROJECT | DERAILLEUR | BRAKE |
|--|---|-------|
| O.D / 線徑 | 1.1mm | 1.5mm |
| STRUCTURE / 結構 |  | |
| SLICK GALVANIZED CABLE SLICK 鍍鋅內線名稱 | SGA-LB | |
| SLICK STAINLESS CABLE SLICK 白鐵內線名稱 | SST-LB | |
| ADVANTAGE 優點 | <ul style="list-style-type: none"> - Double slick process - Polished surface, 10% or more lower friction - Small gaps on surface provides better maneuverability <ul style="list-style-type: none"> · 雙倍研磨加工 (第二層拋光) · 表面拋光，摩擦力低降 10% 以上 · 表面間隙小，提供更好的操控性 | |

DOUBLE SLICK FLEXIBLE

／ 低摩擦研磨多股柔軟型

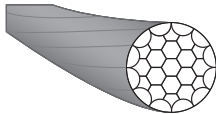
| PROJECT | DERAILLEUR | BRAKE |
|---------------------------------------|---|-------|
| O.D / 線徑 | 1.1mm | 1.5mm |
| STRUCTURE / 結構 |  | |
| SLICK STAINLESS CABLE SLICK 白鐵內線名稱 | LST-LB | |
| ADVANTAGE 優點 | <ul style="list-style-type: none"> - 31 stainless strings, increase the softness of the wire - Overcome the problems of extension - Double slick process, providing better sensitivity when control - Applicable to vehicles with multi-angle route <ul style="list-style-type: none"> · 31 股白鐵線絲，增加線體柔軟度 · 克服延伸的問題 · 雙倍研磨製程，提供更良好的靈敏度 · 適用多角度轉折用車型 | |

CARGO BIKE

/ 高承重載重車型

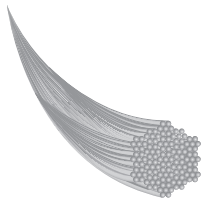
| PROJECT | CARGO BIKE | |
|---------------------------|---|--|
| O.D / 線徑 | 4mm | |
| STRUCTURE / 結構 |  | |
| STAINLESS CABLE 白鐵內線名稱 | NST | |
| ADVANTAGE 優點 | <ul style="list-style-type: none"> - Set with KBH - 11m/m Kevlar Braided Housing - Greased surface keeps the lubricating state for a long time - Can withstand the force brought by heavy loaded vehicles <ul style="list-style-type: none"> · 需搭配 KBH 11m/m 克維拉編織外管 · 表面塗油，長期保持潤滑狀態 · 能承受高承重載重車所帶來的制動力 | |

TEFLON TYPE

/ 鐵氟龍型

| PROJECT | DERAILLEUR | BRAKE |
|----------------------------|---|-------|
| O.D / 線徑 | 1.1mm | 1.5mm |
| STRUCTURE / 結構 |  | |
| GALVANIZED CABLE 鍍鋅內線名稱 | TSG | |
| STAINLESS CABLE 白鐵內線名稱 | TSS | |
| ADVANTAGE 優點 | <ul style="list-style-type: none"> - Improved smoothness after coated Teflon. - Lower friction. - Lubricant surface. - Clean easily. - Heat-resistant 280° C Cold- resistant -20° C. - Available color on Teflon: Black、White、Blue、Red、Green、Yellow、Orange、Pink <ul style="list-style-type: none"> · 表面覆上鐵氟龍可提升順滑度 · 低摩擦係數 · 潤滑平面 · 易清潔保養 · 耐熱攝氏 280° C，抗寒 -20° C · 可生產的鐵氟龍顏色： 黑色、白色、藍色、紅色、綠色、黃色、橘色、粉紅色 | |

INNER CABLE

Nano Type (High Lubrication)

/ 奈米表面型 (高潤滑型)

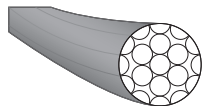
| PROJECT | DERAILLEUR | BRAKE |
|---------------------------|--|-------|
| O.D / 線徑 | 1.1mm | 1.5mm |
| STRUCTURE / 結構 |  | |
| STAINLESS CABLE 白鐵內線名稱 | SPT | |
| ADVANTAGE 優點 | <ul style="list-style-type: none"> - Super smooth surface with no gaps - Nano-processed, coating not easily peel off due to friction - Friction force is more than 8% reduced compared with SST-LB <ul style="list-style-type: none"> · 表面無間隙狀態 · 奈米處理，塗層不會因為摩擦而輕易剝落 · 與 SST-LB 比較，降低 8% 以上摩擦力 | |

» WIRE NIPPLE

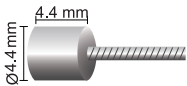
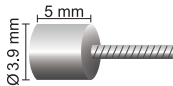
| PROJECT | DERAILLEUR | |
|-------------------|---|---|
| ITEM NO. | N1 | N2 |
| |  |  |
| Compatible system | SHIMANO&SRAM | CAMPAGNOLO |
| SIZE | ø4.4 mm x 4.4 mm | ø3.9 mm x 5 mm |

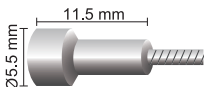
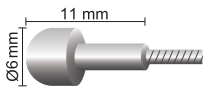
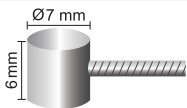
| PROJECT | BRAKE | | |
|-------------------|---|---|---|
| ITEM NO. | N3 | N4 | N5 |
| |  |  |  |
| Compatible system | CAMPAGNOLO (ROAD) | SHIMANO&SRAM (ROAD) | SHIMANO&SRAM (MTB) |
| SIZE | ø5.5 mm x 11.5 mm | ø6 mm x 11 mm | ø7 mm x 6 mm |

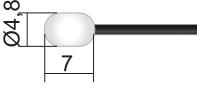
| PROJECT | BMX | |
|-------------------|---|---|
| ITEM NO. | N6 | N7 |
| |  |  |
| Compatible system | BMX | BMX |
| SIZE | ø5 mm | ø4.8 mm x 7 mm |

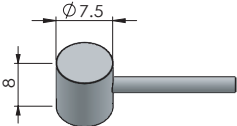
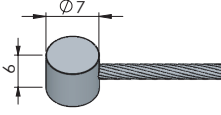
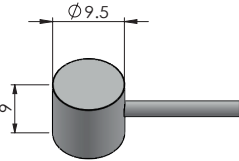
| PROJECT | CARGO BIKE | | |
|-------------------|---|---|--|
| ITEM NO. | N8 | N9 | N10 |
| |  |  |  |
| Compatible system | CARGO BIKE | CARGO BIKE | CARGO BIKE |
| SIZE | ø7.5 mm x 8 mm | ø7 mm x 6 mm | ø9.5 mm x 9mm |



BMX FREE STYLE / BMX 系列

UPPER CABLE

／ 前煞車上移線

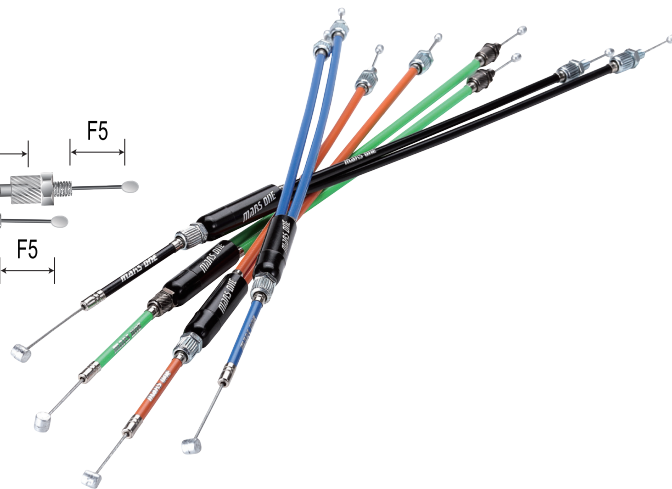

LOWER CABLE

／ 後煞車下移線

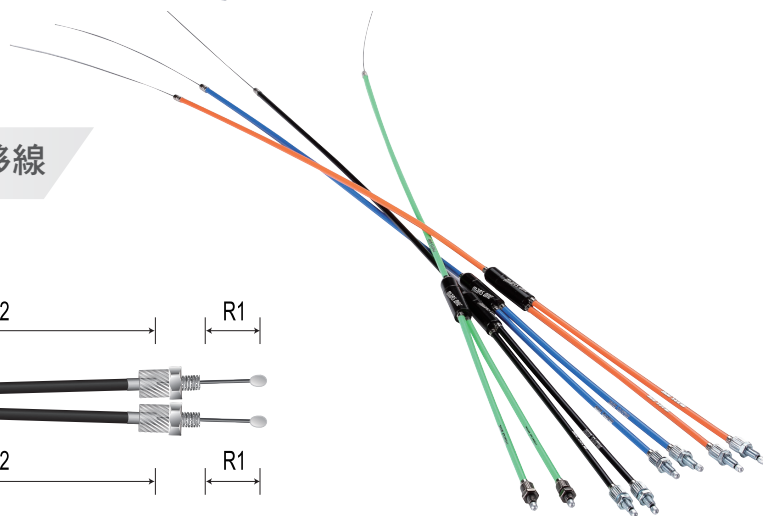
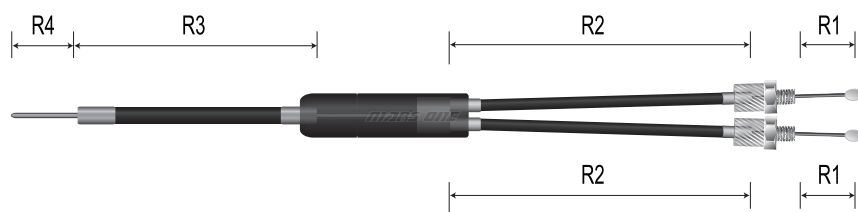

BMX ROTOR



| ITEM NO. | MX-25BK | MX-25SR | MX-29BK | MX-29SR |
|----------|----------|-----------|----------|-----------|
| SIZE | 1" | 1" | 1 1/8" | 1 1/8" |
| MATERIAL | Steel 鐵製 | | | |
| COLOR | Black 黑色 | Silver 銀色 | Black 黑色 | Silver 銀色 |

V-BRAKE

| ITEM NO. | MV-5572CH | MV-5572CHR | MV-9672V |
|-------------|--|--|---|
| | | | |
| DESCRIPTION | New groove design Length 長度：72m/m | 與 MV-5572CH 做替換用 Pad & Pins only Length 長度：72m/m | EN standard compound Length 長度：72m/m |
| ITEM NO. | MV-9472CH | MV-9472CHR | MV-9655CH |
| | | | |
| DESCRIPTION | Holder color sliver, black,titanium,carbon 表面處理 Length 長度：72m/m | 與 MV-9472CH 做替換用 Length 長度：72m/m | For mini bikes and folding bikes. Length 長度：55mm |

R-BRAKE

| ITEM NO. | MR-4757R | MR-4755CH | MR-4755CHR |
|-------------|--|--|-------------------------------------|
| | | | |
| DESCRIPTION | Holder color titanium,black, red,orange | Compatible with all major roc Brakes iriple color | 與 MR-4755CH 做替換用 Length 長度：55m/m |

MTB-BRAKE

| ITEM NO. | MV-72 |
|-------------|--|
| | |
| DESCRIPTION | Holder color: 黑 Black、藍 Blue、紅 Red / Length 長度：72m/m |

BMX-BRAKE

| ITEM NO. | MB-6072V |
|-------------|---|
| | |
| DESCRIPTION | For BMX U-brake / Clear 藍 Blue、綠 Green、紫 Purple / Length 長度：72m/m |

DISK PADS / 來令片

| ITEM NO. | MP-10+OP-10 | MP-11+OP-11 | MP-17+OP-17 | MP-42+OP-42 |
|-------------------|---|---|--|---|
| |  |  |  |  |
| COMPETIBLE SYSTEM | SHIMANO: DEORE MECHANICAL TEKTRO: HYDRAULIC | AVID: JUICY3.5.7 | SHIMANO: XTR BR-M965/M966/ XT2004/SAINT | FORMULA: MEGA ONE,R,R1,RX |
| ITEM NO. | MP-44+OP-44 | MP-52+OP-52 | MP-40+OP-40 | |
| |  |  |  | |
| COMPETIBLE SYSTEM | AVID:ELIXIR | SHIMANO:XTR2011 | HAYES STROKER RYDE,DYNO | |
| ITEM NO. | MP-38 | MP-54 | MP-55 | MPC-52 |
| |  |  |  |  |
| COMPETIBLE SYSTEM | AVID BB5 | SRAM RED | MAGURA:MT2.4.6.8 | SHIMANO XTR |

ALLOY END CAPS-BASIC

/ 鋁製外管端套 - 基本型



| ITEM NO. | OAC-43135BK | OAC-43135BU | OAC-43135YW | OAC-43135PK | OAC-43135GN | OAC-43135RD | OAC-43135SR |
|-----------------|---|----------------------|------------------------|-----------------------|-----------------------|---------------------|------------------------|
| COLOR | Black Anodized 陽極黑 | Blue Anodized 陽極藍 | Yellow Anodized 陽極黃 | Pink Anodized 陽極粉紅 | Green Anodized 陽極綠 | Red Anodized 陽極紅 | Silver Anodized 陽極銀 |
| MATERIAL | Alloy / 鋁 | | | | | | |
| SUITABLE STSTEM | 4mm Derailleur Cable housing / 4mm 變速外管適用 | | | | | | |
| PACKAGE | 100PCS/BOT ; 1000PCS/BAG | | | | | | |

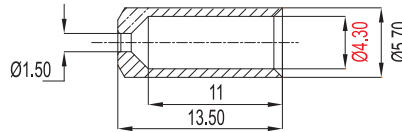

| ITEM NO. | OAC-46145BK | OAC-46145BU | OAC-46145YW | OAC-46145PK | OAC-46145GN | OAC-46145RD | OAC-46145SR |
|-----------------|---|----------------------|------------------------|-----------------------|-----------------------|---------------------|------------------------|
| COLOR | Black Anodized 陽極黑 | Blue Anodized 陽極藍 | Yellow Anodized 陽極黃 | Pink Anodized 陽極粉紅 | Green Anodized 陽極綠 | Red Anodized 陽極紅 | Silver Anodized 陽極銀 |
| MATERIAL | Alloy / 鋁 | | | | | | |
| SUITABLE STSTEM | 4.5mm Derailleur Cable housing / 4.5mm 變速外管適用 | | | | | | |
| PACKAGE | 100PCS/BOT ; 1000PCS/BAG | | | | | | |

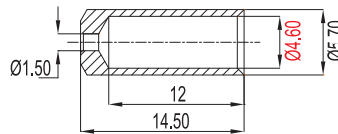

| ITEM NO. | OAC-51155BK | OAC-51155BU | OAC-51155YW | OAC-51155PK | OAC-51155GN | OAC-51155RD | OAC-51155SR |
|-----------------|--------------------------------------|----------------------|------------------------|-----------------------|-----------------------|---------------------|------------------------|
| COLOR | Black Anodized 陽極黑 | Blue Anodized 陽極藍 | Yellow Anodized 陽極黃 | Pink Anodized 陽極粉紅 | Green Anodized 陽極綠 | Red Anodized 陽極紅 | Silver Anodized 陽極銀 |
| MATERIAL | Alloy / 鋁 | | | | | | |
| SUITABLE STSTEM | 5mm Brake Cable housing / 5mm 煞車外管適用 | | | | | | |
| PACKAGE | 100PCS/BOT ; 1000PCS/BAG | | | | | | |

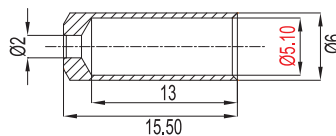

PARTS SERIES

ALLOY END CAPS-WATERPROOF

鋁製外管端套 - 防水型



| ITEM NO. | OAC-43165BK | OAC-43165BU | OAC-43165YW | OAC-43165PK | OAC-43165GN | OAC-43165RD | OAC-43165SR |
|-----------------|---|----------------------|------------------------|-----------------------|-----------------------|---------------------|------------------------|
| COLOR | Black Anodized 陽極黑 | Blue Anodized 陽極藍 | Yellow Anodized 陽極黃 | Pink Anodized 陽極粉紅 | Green Anodized 陽極綠 | Red Anodized 陽極紅 | Silver Anodized 陽極銀 |
| MATERIAL | Alloy / 鋁 | | | | | | |
| SUITABLE STSTEM | 4mm Derailleur Cable housing (Taiwan Patent) / 4mm 變速外管適用 | | | | | | |
| PACKAGE | 100PCS/BOT ; 1000PCS/BAG | | | | | | |

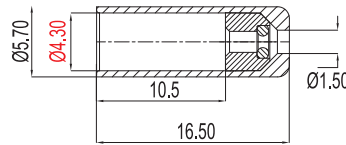

| ITEM NO. | OAC-46165BK | OAC-46165BU | OAC-46165YW | OAC-46165PK | OAC-46165GN | OAC-46165RD | OAC-46165SR |
|-----------------|---|----------------------|------------------------|-----------------------|-----------------------|---------------------|------------------------|
| COLOR | Black Anodized 陽極黑 | Blue Anodized 陽極藍 | Yellow Anodized 陽極黃 | Pink Anodized 陽極粉紅 | Green Anodized 陽極綠 | Red Anodized 陽極紅 | Silver Anodized 陽極銀 |
| MATERIAL | Alloy / 鋁 | | | | | | |
| SUITABLE STSTEM | 4.5mm Derailleur Cable housing (Taiwan Patent) / 4.5mm 變速外管適用 | | | | | | |
| PACKAGE | 100PCS/BOT ; 1000PCS/BAG | | | | | | |

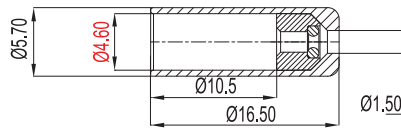

| ITEM NO. | OAC-51165BK | OAC-51165BU | OAC-51165YW | OAC-51165PK | OAC-51165GN | OAC-51165RD | OAC-51165SR |
|-----------------|--|----------------------|------------------------|-----------------------|-----------------------|---------------------|------------------------|
| COLOR | Black Anodized 陽極黑 | Blue Anodized 陽極藍 | Yellow Anodized 陽極黃 | Pink Anodized 陽極粉紅 | Green Anodized 陽極綠 | Red Anodized 陽極紅 | Silver Anodized 陽極銀 |
| MATERIAL | Alloy / 鋁 | | | | | | |
| SUITABLE STSTEM | 5mm Brake Cable housing (Taiwan Patent) / 5mm 煞車外管適用 | | | | | | |
| PACKAGE | 100PCS/BOT ; 1000PCS/BAG | | | | | | |

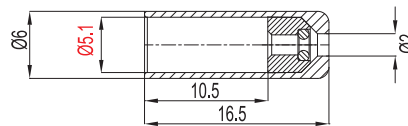

ALLOY END CAPS-LOW FRICTION / 鋁製外管端套 - 低摩擦力型

Feature: Reduce friction while housing and cable be used.
 Liner tubeis black color for 5mm brake End cap.
 Liner tubeis white color for 4mm derailleur End cap.

特色：降低內線與外管在傳導時所產生的摩擦力
 煞車鋁頭內套管為黑色
 變速鋁頭內套管為白色



| ITEM NO. | OAC-43165-10BK | OAC-43165-10BU | OAC-43165-10YW | OAC-43165-10PK | OAC-43165-10GN | OAC-43165-10RD | OAC-43165-10SR |
|-----------------|---|----------------------|------------------------|-----------------------|-----------------------|---------------------|------------------------|
| COLOR | Black Anodized 陽極黑 | Blue Anodized 陽極藍 | Yellow Anodized 陽極黃 | Pink Anodized 陽極粉紅 | Green Anodized 陽極綠 | Red Anodized 陽極紅 | Silver Anodized 陽極銀 |
| MATERIAL | Alloy / 鋁 | | | | | | |
| SUITABLE STSTEM | 4mm Derailleur Cable housing / 4mm 變速外管適用 | | | | | | |
| PACKAGE | 100PCS/BOT ; 1000PCS/BAG | | | | | | |

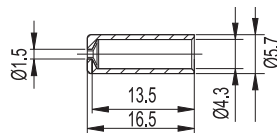

| ITEM NO. | OAC-46165-10BK | OAC-46165-10BU | OAC-46165-10YW | OAC-46165-10PK | OAC-46165-10GN | OAC-46165-10RD | OAC-46165-10SR |
|-----------------|---|----------------------|------------------------|-----------------------|-----------------------|---------------------|------------------------|
| COLOR | Black Anodized 陽極黑 | Blue Anodized 陽極藍 | Yellow Anodized 陽極黃 | Pink Anodized 陽極粉紅 | Green Anodized 陽極綠 | Red Anodized 陽極紅 | Silver Anodized 陽極銀 |
| MATERIAL | Alloy / 鋁 | | | | | | |
| SUITABLE STSTEM | 4.5mm Derailleur Cable housing / 4.5mm 變速外管適用 | | | | | | |
| PACKAGE | 100PCS/BOT ; 1000PCS/BAG | | | | | | |

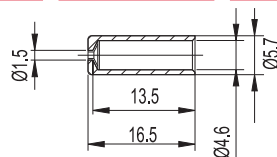

| ITEM NO. | OAC-51165-10BK | OAC-51165-10BU | OAC-51165-10YW | OAC-51165-10PK | OAC-51165-10GN | OAC-51165-10RD | OAC-51165-10SR |
|-----------------|--------------------------------------|----------------------|------------------------|-----------------------|-----------------------|---------------------|------------------------|
| COLOR | Black Anodized 陽極黑 | Blue Anodized 陽極藍 | Yellow Anodized 陽極黃 | Pink Anodized 陽極粉紅 | Green Anodized 陽極綠 | Red Anodized 陽極紅 | Silver Anodized 陽極銀 |
| MATERIAL | Alloy / 鋁 | | | | | | |
| SUITABLE STSTEM | 5mm Brake Cable housing / 5mm 煞車外管適用 | | | | | | |
| PACKAGE | 100PCS/BOT ; 1000PCS/BAG | | | | | | |

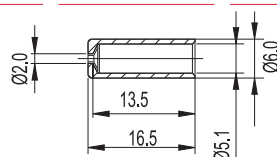

PARTS SERIES

TAILED ALLOY END CAPS/DUST-PROOF

鋁製鼠尾端套 / 防塵型



| ITEM NO. | OAC-43165-35BK | OAC-43165-35BU | OAC-43165-35YW | OAC-43165-35PK | OAC-43165-35GN | OAC-43165-35RD | OAC-43165-35SR |
|-----------------|---|----------------------|------------------------|-----------------------|-----------------------|---------------------|------------------------|
| COLOR | Black Anodized 陽極黑 | Blue Anodized 陽極藍 | Yellow Anodized 陽極黃 | Pink Anodized 陽極粉紅 | Green Anodized 陽極綠 | Red Anodized 陽極紅 | Silver Anodized 陽極銀 |
| MATERIAL | Alloy / 鋁 | | | | | | |
| SUITABLE SYSTEM | 4mm Derailleur Cable housing / 4mm 變速外管適用 | | | | | | |
| PACKAGE | 50PCS/BOT ; 1000PCS/BAG | | | | | | |

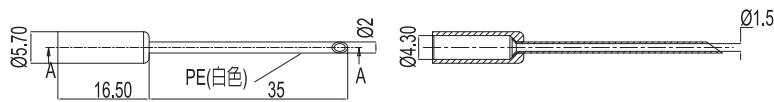

| ITEM NO. | OAC-46165-35BK | OAC-46165-35BU | OAC-46165-35YW | OAC-46165-35PK | OAC-46165-35GN | OAC-46165-35RD | OAC-46165-35SR |
|-----------------|---|----------------------|------------------------|-----------------------|-----------------------|---------------------|------------------------|
| COLOR | Black Anodized 陽極黑 | Blue Anodized 陽極藍 | Yellow Anodized 陽極黃 | Pink Anodized 陽極粉紅 | Green Anodized 陽極綠 | Red Anodized 陽極紅 | Silver Anodized 陽極銀 |
| MATERIAL | Alloy / 鋁 | | | | | | |
| SUITABLE SYSTEM | 4.5mm Derailleur Cable housing / 4.5mm 變速外管適用 | | | | | | |
| PACKAGE | 50PCS/BOT ; 1000PCS/BAG | | | | | | |

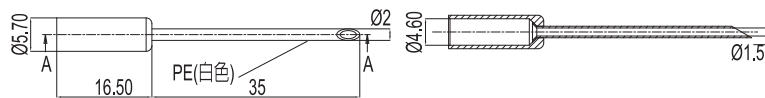



| ITEM NO. | OAC-51165-19BK | OAC-51165-19BU | OAC-51165-19YW | OAC-51165-19PK | OAC-51165-19GN | OAC-51165-19RD | OAC-51165-19SR |
|-----------------|--------------------------------------|----------------------|------------------------|-----------------------|-----------------------|---------------------|------------------------|
| COLOR | Black Anodized 陽極黑 | Blue Anodized 陽極藍 | Yellow Anodized 陽極黃 | Pink Anodized 陽極粉紅 | Green Anodized 陽極綠 | Red Anodized 陽極紅 | Silver Anodized 陽極銀 |
| MATERIAL | Alloy / 鋁 | | | | | | |
| SUITABLE STSTEM | 5mm Brake Cable housing / 5mm 煞車外管適用 | | | | | | |
| PACKAGE | 50PCS/BOT ; 1000PCS/BAG | | | | | | |

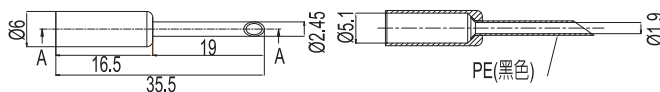

| ITEM NO. | OAC-51165-35BK | OAC-51165-35BU | OAC-51165-35YW | OAC-51165-35PK | OAC-51165-35GN | OAC-51165-35RD | OAC-51165-35SR |
|-----------------|--------------------------------------|----------------------|------------------------|-----------------------|-----------------------|---------------------|------------------------|
| COLOR | Black Anodized 陽極黑 | Blue Anodized 陽極藍 | Yellow Anodized 陽極黃 | Pink Anodized 陽極粉紅 | Green Anodized 陽極綠 | Red Anodized 陽極紅 | Silver Anodized 陽極銀 |
| MATERIAL | Alloy / 鋁 | | | | | | |
| SUITABLE STSTEM | 5mm Brake Cable housing / 5mm 煞車外管適用 | | | | | | |
| PACKAGE | 50PCS/BOT ; 1000PCS/BAG | | | | | | |

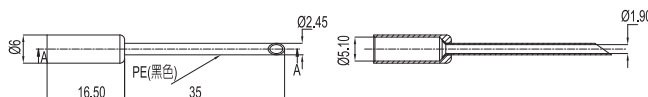

PARTS SERIES

ALLOY END CAPS/INTERGRATED

鋁製外管端套 / 內埋式型



Feature: Suitable to frame intergrated.

特色：內埋式車架專用端套



| ITEM NO. | OAC-43165-1500BK | OAC-43165-1500BU | OAC-43165-1500YW | OAC-43165-1500PK | OAC-43165-1500GN | OAC-43165-1500RD | OAC-43165-1500SR |
|-----------------|---|----------------------|------------------------|-----------------------|-----------------------|---------------------|------------------------|
| COLOR | Black Anodized 陽極黑 | Blue Anodized 陽極藍 | Yellow Anodized 陽極黃 | Pink Anodized 陽極粉紅 | Green Anodized 陽極綠 | Red Anodized 陽極紅 | Silver Anodized 陽極銀 |
| MATERIAL | Alloy / 鋁 | | | | | | |
| SUITABLE STSTEM | 4mm Derailleur Cable housing / 4mm 變速外管適用 | | | | | | |
| PACKAGE | 50PCS/BUNDLE | | | | | | |

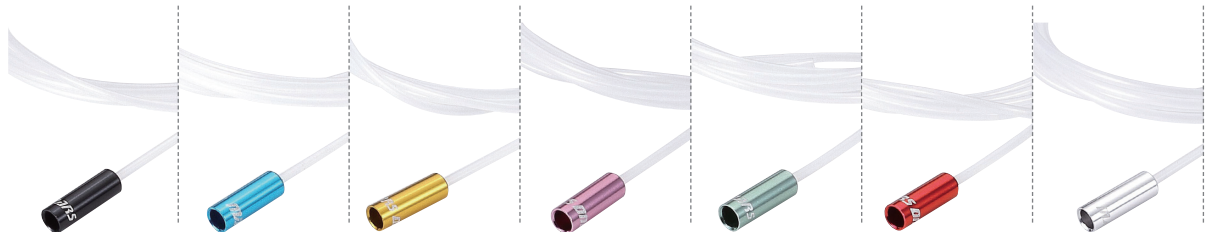
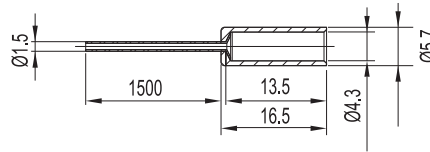

| ITEM NO. | OAC-46165-35BK | OAC-46165-35BU | OAC-46165-35YW | OAC-46165-35PK | OAC-46165-35GN | OAC-46165-35RD | OAC-46165-35SR |
|-----------------|---|----------------------|------------------------|-----------------------|-----------------------|---------------------|------------------------|
| COLOR | Black Anodized 陽極黑 | Blue Anodized 陽極藍 | Yellow Anodized 陽極黃 | Pink Anodized 陽極粉紅 | Green Anodized 陽極綠 | Red Anodized 陽極紅 | Silver Anodized 陽極銀 |
| MATERIAL | Alloy / 鋁 | | | | | | |
| SUITABLE STSTEM | 4.5mm Derailleur Cable housing / 4.5mm 變速外管適用 | | | | | | |
| PACKAGE | 50PCS/BUNDLE | | | | | | |

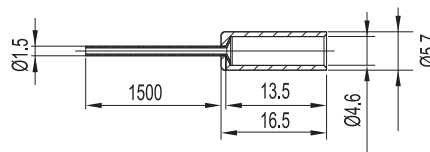

CARGO BIKE-LOW FRICTION / 滑順型



| ITEM NO. | OAC-61165-10BK | OAC-61165-10RD | OAC-61165-10SR |
|-----------------|---|---------------------|------------------------|
| COLOR | Black Anodized 陽極黑 | Red Anodized 陽極紅 | Silver Anodized 陽極銀 |
| MATERIAL | Alloy / 鋁 | | |
| SUITABLE STSTEM | 6mm Derailleur Cable housing / 6mm 變速外管適用 | | |

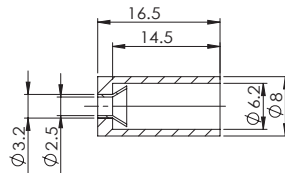

CARGO BIKE-DUST-PROOF / 防塵型



| ITEM NO. | OAC-61165-35BK | OAC-61165-35RD | OAC-61165-35SR |
|-----------------|------------------------------|---------------------|------------------------|
| COLOR | Black Anodized 陽極黑 | Red Anodized 陽極紅 | Silver Anodized 陽極銀 |
| MATERIAL | Alloy / 鋁 | | |
| SUITABLE STSTEM | 6mm Cable housing / 6mm 外管適用 | | |

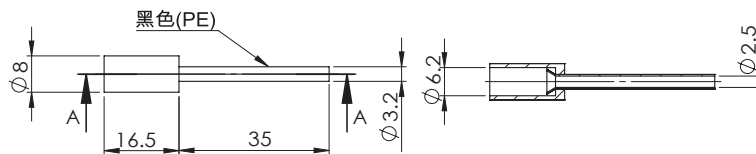

CARGO BIKE-HIGH LOAD / 高承重載重車用端套

| ITEM NO. | OAC-11320BK |
|-----------------|--------------------------------|
| COLOR | Black Anodized / 陽極黑 |
| MATERIAL | Alloy / 鋁 |
| SUITABLE STSTEM | 11mm Cable housing / 11mm 外管適用 |

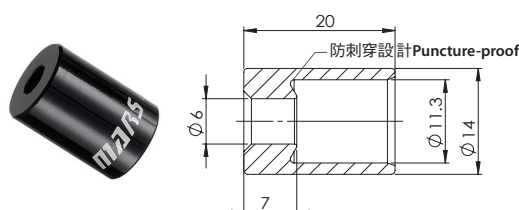

PARTS SERIES

BRASS END CAPS/INTERGRATED / 銅製外管端套



| ITEM NO. | OBC-4211SR | OBC-4312SR | OBC-4312BK | OBC-42125SR |
|-----------------|--|--|------------------|--|
| COLOR | Nickel Plated / 鍍鎳 | | Black Plate/ 電鍍黑 | Nickel Plated / 鍍鎳 |
| | | | | |
| MATERIAL | Brass / 銅 | | | |
| SUITABLE SYSTEM | 4mm Derailleur Cable Housing 4mm 變速外管適用 | 4mm Derailleur Cable Housing (CNC) 4mm 變速外管適用 (CNC) | | 4mm Derailleur Cable Housing Competible to Sturmey Archer Shifting Cable Set Compatible 適用於 Sturmey Archer 內三速系列，適用於 4mm 變速外管 |
| PACKAGE | 300PCS/BOT ; 5000PCS/BAG | | | |



| ITEM NO. | OBC-4612SR | OBC-5110SR | OBC-5111SR | OBC-5111BK |
|-----------------|--|---------------------------------------|---------------------------------------|------------------|
| COLOR | Nickel Plated / 鍍鎳 | | | Black Plated 電鍍黑 |
| | | | | |
| MATERIAL | Brass / 銅 | | | |
| SUITABLE SYSTEM | 4.5mm Derailleur Cable Housing (CNC) 4.5mm 變速外管適用 (CNC) | 5mm Brake Cable Housing 5mm 煞車外管適用 | 5mm Brake Cable Housing 5mm 煞車外管適用 | |
| PACKAGE | 200PCS/BOT ; 5000PCS/BAG | | | |



| ITEM NO. | OBC-5111SR-N | OBC-5112SR | OBC-5112-4BK-NT | OBC-5918SR |
|-----------------|--|--|-----------------|---|
| COLOR | Nickel Plated / 鍍銀 | | Black Plate 電鍍黑 | Nickel Plated / 鍍銀 |
| | | | | |
| MATERIAL | Brass / 銅 | | | |
| SUITABLE SYSTEM | 5mm Brake Cable Housing (NON-Crimping Cup) 5mm 煞車外管適用 (免壓式端套) | 5mm Derailleur Cable Housing (CNC) 5mm 變速外管適用 (CNC) | | Suitable for the connect tubes of SHIMANO Shifters. The 2 stages structure design is able to directly plug into the shifters, and it will not be easily separated from the shifters. 適用於 SHIMANO 變速把手連結端套，二段式設計可直接插入變速把手，不易與變速把手離脫 |
| PACKAGE | 200PCS/BOT ; 5000PCS/BAG | | | 1000PCS/BAG |

PLASTIC END CAPS / 塑膠製端套



| ITEM NO. | OPC-4216BK | OPC-4017BK | OPC-4218BK | OPC-4017BK-S |
|-----------------|--|------------|--|---|
| COLOR | Black / 黑色 | | | |
| | | | | |
| MATERIAL | Plastic / 塑膠 | | | Plastic / 塑膠 ; Brass / 銅 |
| SUITABLE SYSTEM | 4mm Derailleur Cable Housing 4mm 變速外管適用 | | 4mm Derailleur Cable Housing Compacted Better 4mm 變速外管適用 緊密度佳 | 4mm Derailleur Cable Housing Waterproof 4mm 變速外管適用 (防水) |
| PACKAGE | 150PCS/BOT ; 2000PCS/BAG | | | |



| ITEM NO. | OPC-4616BK | OPC-5017BK | OPC-5020BK |
|-----------------|--|------------|-------------------------------|
| COLOR | Black / 黑色 | | |
| | | | |
| MATERIAL | Plastic / 塑膠 | | |
| SUITABLE SYSTEM | 4.5mm Derailleur Cable Housing 4.5mm 變速外管適用 | | 5mm Cable Housing 5mm 外管適用 |
| PACKAGE | 150PCS/BOT ; 2000PCS/BAG | | 100PCS/BOT ; 2000PCS/BAG |

PARTS SERIES

PLASTIC TAILED END CAPS / 塑膠製鼠尾端套



| ITEM NO. | OPC-4232BK | OPC-4247BK | OPC-4344BK |
|-----------------|---|------------|------------|
| COLOR | Black / 黑色 | | |
| | | | |
| MATERIAL | Plastic / 塑膠 | | |
| SUITABLE SYSTEM | 4mm Derailleur Cable Housing / 4mm 變速外管適用 | | |
| PACKAGE | 100PCS/BOT ; 2000PCS/BAG | | |



| ITEM NO. | OPC-4321BK | OPC-5131BK | OPC-5135BK |
|-----------------|--|-------------------------------|------------|
| COLOR | Black / 黑色 | | |
| | | | |
| MATERIAL | Plastic / 塑膠 | | |
| SUITABLE SYSTEM | 4mm Derailleur Cable Housing 4mm 變速外管適用 | 5mm Cable Housing 5mm 外管適用 | |
| PACKAGE | 100PCS/BOT ; 2000PCS/BAG | | |

CABLE TIPS / 內線尾套



| ITEM NO. | BMA-2110 | BMA-2110BK | BMA-2110BU | BMA-2110YW | BMA-2110PK | BMA-2110GN | BMA-2110RD | BMA-2110SR |
|-----------------|--|--------------------------|-------------------------|---------------------------|--------------------------|--------------------------|------------------------|---------------------------|
| COLOR | Silver 鋁本色 | Black Anodized 陽極黑 | Blue Anodized 陽極藍 | Yellow Anodized 陽極黃 | Pink Anodized 陽極粉紅 | Green Anodized 陽極綠 | Red Anodized 陽極紅 | Silver Anodized 陽極銀 |
| MATERIAL | | | | | | | | |
| SUITABLE STSTEM | 1.1~1.2mm Shift inner cable / 1.1~1.2mm 變速內線適用 | | | | | | | |
| PACKAGE | 500PCS/BOT ; 10000PCS/BAG | | | | | | | |



| ITEM NO. | BMA-2211 | BMA-2211BK | BMA-2211BU | BMA-2211YW | BMA-2211PK | BMA-2211GN | BMA-2211RD | BMA-2211SR |
|-----------------|---|--------------------------|-------------------------|---------------------------|--------------------------|--------------------------|------------------------|---------------------------|
| COLOR | Silver 鋁本色 | Black Anodized 陽極黑 | Blue Anodized 陽極藍 | Yellow Anodized 陽極黃 | Pink Anodized 陽極粉紅 | Green Anodized 陽極綠 | Red Anodized 陽極紅 | Silver Anodized 陽極銀 |
| MATERIAL | | | | | | | | |
| SUITABLE STSTEM | 1.1~1.6mm brake & Shift inner cable / 1.1~1.6mm 煞車 & 變速內線適用 | | | | | | | |
| PACKAGE | 500PCS/BOT ; 10000PCS/BAG | | | | | | | |



| ITEM NO. | BMA-2416 | PT001RW | BMA-3115RD |
|-----------------|---|--|--|
| COLOR | Clean / 表面酸洗 | Red / White Logo ; 紅色 / 白字 | Red / 紅色 |
| MATERIAL | | | |
| SUITABLE STSTEM | 1.8~2.0mm brake inner cable 1.8~2.0mm 煞車內線適用 | Link Tube Suit to Brake&Derailleur Cable Housing, Fit between hose and end cap to prevent cap loosen also waterproof (Taiwan Patent) 橡膠防塵套 煞車 & 變速外管適用，連接於外 管與端套之間，防止水流入外管 內，防水功能極佳 | Setting into shift or brake cable end tips For more protection, and increasing the delicate sense of the bikes. 套入變速或煞車線尾套上，多層 保護，更增添自行車的質感 |
| PACKAGE | 300PCS/BOT ; 10000PCS/BAG | 50PCS/BOT ; 1000PCS/BAG | 200PCS/BOT ; 1000PCS/BAG |



Spiral Wrap / 捲式結束帶



| ITEM NO. | SWB6 |
|----------|--|
| COLOR | Black Fluorescent (green, yellow, red, orange, pink, dark blue, light blue, light green) 黑色 螢光 (綠, 黃, 紅, 橘, 粉紅, 深藍, 淺藍, 淺綠) |
| | |
| MATERIAL | PE |
| PACKAGE | 1000M/ROLL / 10M/BAG |

Foam Tube / 發泡管



| ITEM NO. | NBR0609 |
|----------|------------|
| COLOR | Black / 黑色 |
| | |
| MATERIAL | NBR |
| PACKAGE | 10M/BAG |

TUBE PROTECTOR / 保護套



| ITEM NO. | FP-1245RD | FP-1245BK | FP-0910BK | FP-0910RD |
|-----------------|--|------------|--------------------------|-----------|
| COLOR | Red / 紅色 | Black / 黑色 | Black / 黑色 | Red / 紅色 |
| MATERIAL | Silica Gel / 矽膠 | | | |
| SUITABLE STSTEM | Frame protector Fits 4, 4.5, 5 mm housings 車架保護套 4mm/4.5mm/5mm 外管適用 | | | |
| PACKAGE | 30PCS/BOT ; 1000PCS/BAG | | 100PCS/BOT ; 1000PCS/BAG | |



| ITEN NO. | COLOR | ITEN NO. | COLOR |
|------------|---------------------------|-----------|-------------------|
| FP-0760BK | Black / 黑色 | FP-0760LU | Noctilucent / 夜光色 |
| FP-0760BL | Blue / 藍色 | FP-0760OR | Orange / 橘色 |
| FP-0760CL | Transparent / 透明色 | FP-0760PK | Pink / 粉紅色 |
| FP-0760CLY | Fluorescent Yellow / 螢光黃色 | FP-0760PL | Purple / 紫色 |
| FP-0760GD | Gold / 金色 | FP-0760RD | Red / 紅色 |
| FP-0760GR | Green / 綠色 | FP-0760SL | Silver / 銀色 |
| FP-0760GY | Gray / 灰色 | FP-0760WH | White / 白色 |
| FP-0760LPL | Lavender / 薰衣草紫色 | FP-0760YW | Yellow / 黃色 |

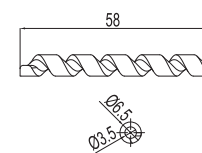

| | |
|-----------------|---|
| MATERIAL | TPR / 橡膠 |
| SUITABLE STSTEM | Frame protector Fits 4, 4.5, 5mm Housings 車架保護套 4mm/4.5mm/5mm 外管適用 |
| PACKAGE | 30PCS/BOT ; 1000PCS/BAG |

HUBS / 集線器



| ITEM NO. | BMA-05166WH | BMA-05166BK | BMA-05186WH | BMA-05186BK | ST-3825BK | ST-4541BK |
|-----------------|---|-------------|---|-------------|--------------------------------------|-----------|
| COLOR | White / 白色 | Black / 黑色 | White / 白色 | Black / 黑色 | Black / 黑色 | |
| MATERIAL | Pom / 塑膠鋼 | | | | Silica Gel / 矽膠 | |
| SUITABLE STSTEM | Suit to 4mm housing + DI2 electronic wire 適用於 4mm 外管與 DI2 電子變速包線 | | Suit to 4、5mm housing 適用於 4mm 與 5mm 外管 | | Suit to 4mm tailed cap 4mm 鼠尾端套適用 | |
| PACKAGE | 150PCS/BOT;1000PC/BAG | | 100PCS/BOT;1000PC/BAG | | 1000PCS/BAG | |

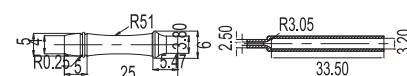
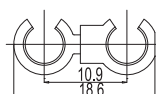
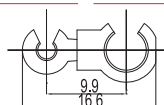

RUBBER DIRT PROOF SLEEVE / 防塵套



PARTS SERIES

PLUG FOR INTEGRATED FRAME / 車架止栓保護套

| ITEM NO. | PU-2509CH | PU-5009OH |
|-----------------|--|---------------------|
| COLOR | Black / 黑色 | |
| | | |
| MATERIAL | Crosscutting with hole / 剖溝有孔膠塞 | Without hole / 無孔膠塞 |
| SUITABLE SYSTEM | SHIMANO DI2 electronic system / 適用於 SHIMANO DI2 系統 | |
| PACKAGE | 200PCS/BOT ; 1000PCS/BAG | |

ADJUSTER SCREW FOR M5 / M5 調整螺絲



| ITEM NO. | AJ-1130M5BK | AJ-1130M5MB | AJ-1130M5MW |
|-----------------|---|-------------------------|-------------------------|
| COLOR | Black / 黑色 | Black Soft Paint / 皮革漆黑 | White Soft Paint / 皮革漆白 |
| | | | |
| MATERIAL | Iron 鐵 / Plastic 塑膠 | | |
| SUITABLE SYSTEM | Used to down tube for ROAD bikes 公路車車架下管用之 M5 調整螺絲 | | |
| PACKAGE | 20PCS/BOT ; 500PCS/BAG | | |

ADJUSTER SCREW FOR SHIFTING / 變速調整螺絲



| ITEM NO. | IL-6862GB | IL-6862MB | IL-6862GG | IL-6862MW |
|-----------------|---|--------------------------|---------------------------------------|--------------------------|
| COLOR | Black Anodized 陽極黑 | Black Soft Paint 皮革漆黑 | Shimano Gray Anodized 陽極 Shimano 灰 | White Soft Paint 皮革漆白 |
| | | | | |
| MATERIAL | Alloy / 鋁 | | | |
| SUITABLE SYSTEM | Suit to housing with plastic end caps 適用穿塑膠端套之外管 | | | |
| PACKAGE | 50PCS/BOT ; 1000PCS/BAG | | | |

ADJUST SCREW-DUCK TYPE / 定格調整螺絲



| ITEM NO. | AL-082843GG | AL-082843GD | AL-082843GR | AL-082843GB |
|-----------------|---|----------------------|---------------------|-----------------------|
| COLOR | Shimano Gray Anodized 陽極 Shimano 灰 | Gold Anodized 陽極金 | Red Anodized 陽極紅 | Black Anodized 陽極黑 |
| MATERIAL | Alloy / 鋁 | | | |
| SUITABLE SYSTEM | Suit to housing without end caps 適用不穿端套之外管 | | | |
| PACKAGE | 50PCS/BOT ; 1000PCS/BAG | | | |

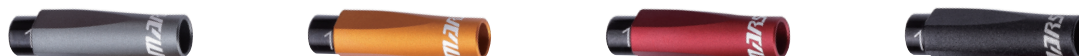
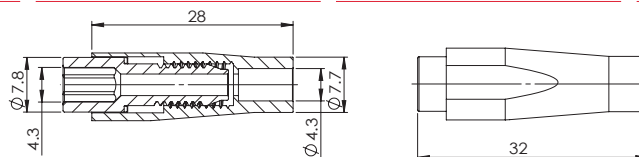

| ITEM NO. | AL-082843SG | AL-082843SGD | AL-082843SR | AL-082843SB |
|-----------------|---|---------------------------|--------------------------|----------------------------|
| COLOR | Shimano Gray Sand Anodized / 噴砂灰 | Gold Sand Anodized 噴砂金 | Red Sand Anodized 噴砂紅 | Black Sand Anodized 噴砂黑 |
| MATERIAL | Alloy / 鋁 | | | |
| SUITABLE SYSTEM | Suit to housing without end caps 適用不穿端套之外管 | | | |
| PACKAGE | 50PCS/BOT ; 1000PCS/BAG | | | |

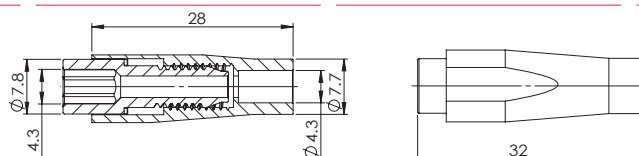

ADJUSTER SCREW FOR BRAKE

煞車調整螺絲

» **ADJUST SCREW-DUCK TYPE**
定格調整螺絲



| ITEM NO. | AL-082851GB |
|-----------------|---|
| COLOR | Black Anodized / 陽極黑 |
| MATERIAL | Alloy / 鋁 |
| SUITABLE SYSTEM | Suit to housing without end caps 適用不穿端套之外管 |
| PACKAGE | 50PCS/BOT ; 1000PCS/BAG |

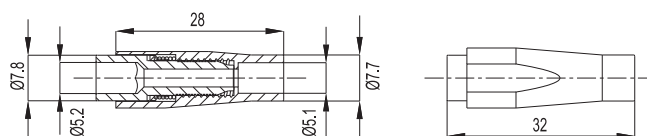

PARTS SERIES

O-RINGS

/ O 型環

Feature: Scratch proof available. / 內線防刮車架功能



| ITEM NO. | IOR-1211BO | IOR-1211TO | IOR-1211REO | IOR-1211BUO | IOR-1211GNO | IOR-1211YWO | IOR-1211BR | IOR-1211TR |
|-----------------|---|-------------------|-------------|-------------|-------------|--------------|---|-------------------|
| COLOR | Black 黑色 | Transparent 透明 | Red 紅色 | Blue 藍色 | Green 綠色 | Yellow 黃色 | Black 黑色 | Transparent 透明 |
| MATERIAL | TPR / 熱塑性橡膠 | | | | | | | |
| SUITABLE SYSTEM | 1.1~1.2mm Shift cable 1.1~1.2mm 變速內線適用 Octagonal Shape/ 八角形 | | | | | | 1.1~1.2mm Shift cable. scratch proof available. 1.1~1.2mm 變速內線適用 Round Shape/ 圓形 | |
| PACKAGE | 200PCS/BOT ; 2000PCS/BAG | | | | | | | |



| ITEM NO. | IOR-1610BO | IOR-1610TO | IOR-1610REO | IOR-1610BUO | IOR-1610GNO | IOR-1610YWO | IOR-1610BR | IOR-1610TR |
|-----------------|---|-------------------|-------------|-------------|-------------|--------------|---|-------------------|
| COLOR | Black 黑色 | Transparent 透明 | Red 紅色 | Blue 藍色 | Green 綠色 | Yellow 黃色 | Black 黑色 | Transparent 透明 |
| MATERIAL | TPR / 熱塑性橡膠 | | | | | | | |
| SUITABLE SYSTEM | 1.5~1.6mm brake cable 1.5~1.6mm 煞車內線適用 Octagonal Shape/ 八角形 | | | | | | 1.5~1.6mm brake cable. scratch proof available. 1.5~1.6mm 煞車內線適用 Round Shape/ 圓形 | |
| PACKAGE | 200PCS/BOT ; 2000PCS/BAG | | | | | | | |

PRESTA VALVE CUP / 法式氣嘴蓋

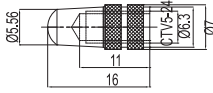

| ITEM NO. | PVC7016BK | PVC7016GY | PVC7016GD | PVC7016BU | PVC7016GN | PVC7016PK | PVC7016RD | PVC7016SR |
|-----------------|--|---------------------------------------|----------------------|----------------------|-----------------------|-----------------------|---------------------|------------------------|
| COLOR | Black Anodized 陽極黑 | Shimano Gray Anodized 陽極 Shimano 灰 | Gold anodized 陽極金 | Blue anodized 陽極藍 | Green anodized 陽極綠 | Pink anodized 陽極粉紅 | Red anodized 陽極紅 | Silver anodized 陽極銀 |
| MATERIAL |  Alloy / 鋁 | | | | | | | |
| SUITABLE SYSTEM | ROAD Bike / 公路車適用 | | | | | | | |
| PACKAGE | 100PCS/BOT ; 2000PCS/BAG | | | | | | | |



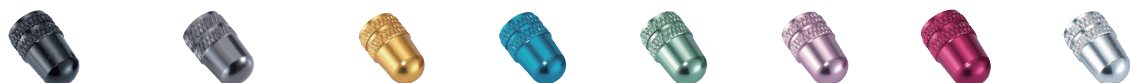

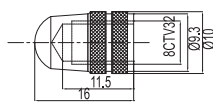





SCHRADER VALVE CUP / 美式氣嘴蓋

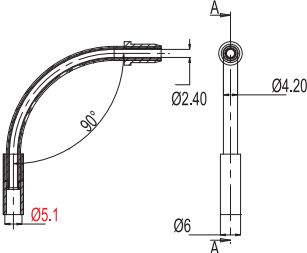
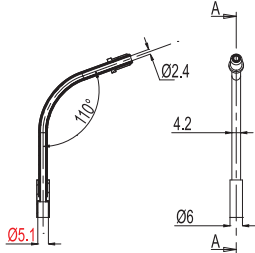
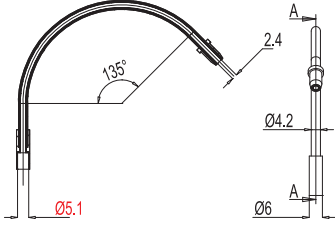

| ITEM NO. | SVC1016BK | SVC1016GY | SVC1016GD | SVC1016BU | SVC1016GN | SVC1016PK | SVC1016RD | SVC1016SR |
|-----------------|--|---------------------------------------|----------------------|----------------------|-----------------------|-----------------------|---------------------|------------------------|
| COLOR | Black Anodized 陽極黑 | Shimano Gray Anodized 陽極 Shimano 灰 | Gold anodized 陽極金 | Blue anodized 陽極藍 | Green anodized 陽極綠 | Pink anodized 陽極粉紅 | Red anodized 陽極紅 | Silver anodized 陽極銀 |
| MATERIAL |  Alloy / 鋁 | | | | | | | |
| SUITABLE SYSTEM | MTB Bike / 登山車適用 | | | | | | | |
| PACKAGE | 100PCS/BOT ; 2000PCS/BAG | | | | | | | |

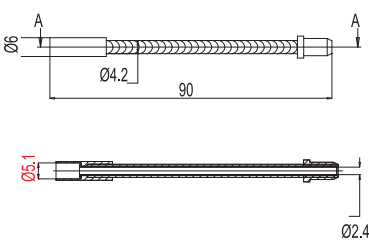
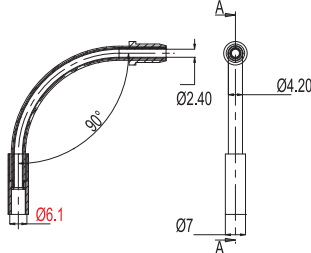
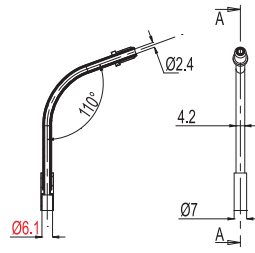
PARTS SERIES

V-BRAKE PARTS / V-煞系統專用零件

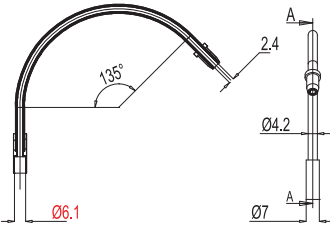
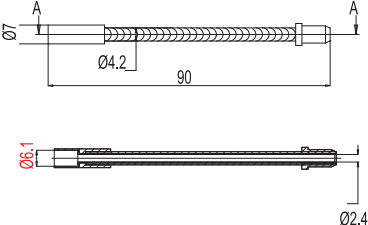
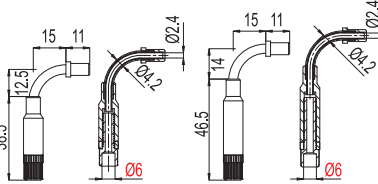
| | | | | | |
|--------------------|--|--|---|----------------------------------|---------------------|
| |  |  |  | | |
| ITEM NO. | MGP-5190ST | MGP-5110ST | MGP-51135ST | | |
| MATERIAL | Stainless / 白鐵 | Stainless / 白鐵 | Stainless / 白鐵 | | |
| DESCRIPTION |  <p>Guide Pipe 90° / 90 度彎管 Suit 5mm brake housing without end cap / 適用於未穿入端套的 5mm 煞車外管</p> |  <p>Guide Pipe 110° / 110 度彎管 Suit 5mm brake housing without end cap / 適用於未穿入端套的 5mm 煞車外管</p> |  <p>Guide Pipe 135° / 135 度彎管 Suit 5mm brake housing without end cap / 適用於未穿入端套的 5mm 煞車外管</p> | | |
| QTY | | 500PCS/BAG | | | |
| |  |  |  | | |
| ITEM NO. | MGP-51FREEIR | MGP-51FREEST | MGP-6190ST | MGP-6110ST | |
| MATERIAL | Iron / 鐵 | Stainless / 白鐵 | Stainless / 白鐵 | Stainless / 白鐵 | |
| DESCRIPTION |  <p>Guide Pipe Flexible / 自由式彎管 Suit 5mm brake housing without end cap / 適用於未穿入端套的 5mm 煞車外管</p> |  <p>Guide Pipe 90° / 90 度彎管 Suit 5mm brake housing without end cap / 適用於已穿入端套的 5mm 煞車外管</p> |  <p>Guide Pipe 110° / 110 度彎管 Suit 5mm brake housing without end cap / 適用於已穿入端套的 5mm 煞車外管</p> | | |
| QTY | | 500PCS/BAG | | | |
| |  |  |  | | |
| ITEM NO. | MGP-61135ST | MGP-61FREEIR | MGP-61FREEST | MGP-5890BK | MGP-5890BK-1 |
| MATERIAL | Stainless / 白鐵 | Iron / 鐵 | Stainless / 白鐵 | Stainless;Black Plated / 白鐵; 電鍍黑 | |
| DESCRIPTION |  <p>Guide Pipe 135° / 135 度彎管 Suit 5mm brake housing without end cap / 適用於已穿入端套的 5mm 煞車外管</p> |  <p>Guide Pipe Flexible° / 自由式彎管 Suit 5mm brake housing without end cap / 適用於已穿入端套的 5mm 煞車外管</p> |  <p>Suit to 5mm housing with end cap. Flexible with adjust screw. 適用於已穿入端套的 5mm 煞車外管，調整螺絲可彈性調整</p> | | |
| QTY | | 500PCS/BAG | | 50PCS/BAG | |

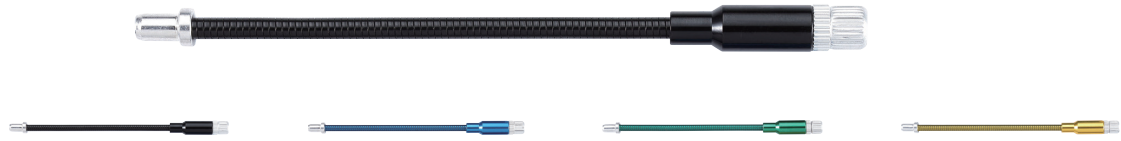

| ITEM NO. | MGP-61FREEBK | MGP-61FREEBU | MGP-61FREEGN | MGP-61FREEYW |
|-----------------|---|----------------------|-----------------------|------------------------|
| COLOR | Black anodized 陽極黑 | Blue anodized 陽極藍 | Green anodized 陽極綠 | Yellow anodized 陽極黃 |
| MATERIAL | Iron / 鐵 ; Alloy / 鋁 | | | |
| SUITABLE STSTEM | Guide pipe flexible 0°~180° / 自由式彎管 0°~180° | | | |
| QTY | 500PCS/BAG | | | |

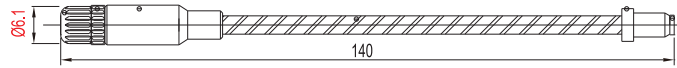

| ITEM NO. | MGP-61FREERD | MGP-FREEBK-1 | MGP-FREEBK-2 |
|-----------------|---|-----------------------|--------------|
| COLOR | Red anodized 陽極紅 | Black anodized 陽極黑 | |
| MATERIAL | Iron / 鐵 ; Alloy / 鋁 | | |
| SUITABLE STSTEM | Guide pipe flexible 0°~180° / 自由式彎管 0°~180° | | |
| QTY | 500PCS/BAG | | |

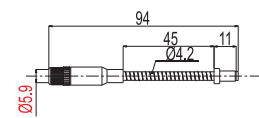
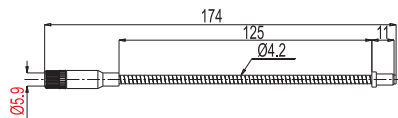
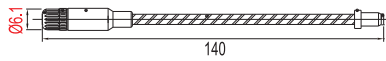

| ITEM NO. | MPB-8248BK | MPB-7055BK | FC0028PB |
|-----------------|---------------------------------------|------------|--|
| MATERIAL | Rubber / 橡膠 | | Plastic / 塑膠 |
| SUITABLE STSTEM | V-Brake Protective Boot / V- 煞系統用保護套° | | Suit to flexible to frame 將外管固定於車架之用束 |
| QTY | 2500PCS/BAG | | 1000PCS/BAG |

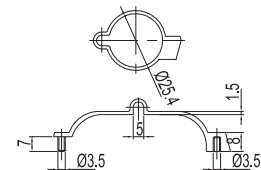
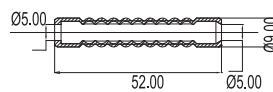
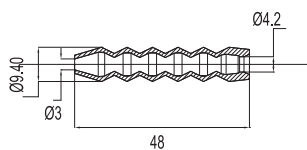

PARTS SERIES

BMX FREE STYLE ADJUSTING SCREW

/ BMX 車種用調整螺絲



| ITEM NO. | MAS-0925BK | MAS-1023SR |
|-----------------|-------------------------------------|--------------------|
| COLOR | Argon Black Plated / 鍍黑色 | Argon Plated / 鍍鉻色 |
| | | |
| MATERIAL | Iron / 鐵 | |
| SUITABLE STSTEM | BMX Free Style Bicycles / BMX 表演車種用 | |
| PACKAGE | 2000PCS/BAG | |

ADJUSTING SCREW

/ 調整螺絲



| ITEM NO. | MAS-0620SR | MAS-0625SR-2 | MAS-0635SR | MAS-0640SR-1 |
|-----------------|--|--------------|------------|--------------|
| COLOR | Argon Plated / 鍍鉻色 | | | |
| | | | | |
| MATERIAL | Iron / 鐵 | | | |
| SUITABLE STSTEM | M6 Adjust Screw Suitable Break & Shifting System / M6 調整螺絲 煞車 / 變速系統使用 | | | |
| PACKAGE | 2000PCS/BAG | | | |



| ITEM NO. | OAS-5029SR | OAS-5044SR | MAS-2650SR-2 |
|-----------------|---|--------------------|--------------------|
| COLOR | Argon Plated / 鍍鉻色 | Nickel Plated / 鍍鎳 | Argon Plated / 鍍鉻色 |
| | | | |
| MATERIAL | Iron / 鐵 | | |
| SUITABLE STSTEM | M6 Adjust Screw Fixed to 5mm cable housing / M6 調整螺絲 / 5mm 煞車外管適用 | | |
| PACKAGE | 2000PCS/BAG | | |

BRAKE LEVER ADJUSTER

／ 剖溝螺絲 - 煞車把手用



| ITEM NO. | MAB-7525BK | MAB-7426SR-B |
|-----------------|---|-----------------------|
| COLOR | Black Plated / 鍍黑 | Silver Anodized / 陽極銀 |
| | | |
| MATERIAL | Iron / 鐵 | Alloy / 鋁 |
| SUITABLE STSTEM | M7 Adjust Suitable to Brake Lever / M7 剖溝螺絲 | |
| PACKAGE | 1000PCS/BAG | |



| ITEM NO. | MAB-7526SR-A | MAB-7526DU-A | MAB-7526GD-A | MAB-7526GN-A | MAB-7526OG-A | MAB-7526PE-A | MAB-7526RD-A |
|-----------------|---|-------------------------|-------------------|--------------------|---------------------|---------------------|------------------|
| COLOR | Silver Anodized 陽極銀 | Dark blue Anodized 陽極深藍 | Gold Anodized 陽極金 | Green Anodized 陽極綠 | Oragen Anodized 陽極橘 | Purple Anodized 陽極紫 | Red Anodized 陽極紅 |
| | | | | | | | |
| MATERIAL | Alloy / 鋁 | | | | | | |
| SUITABLE STSTEM | M7 Adjust Suitable to Brake Lever / M7 剖溝螺絲 | | | | | | |
| PACKAGE | 1000PCS/BAG | | | | | | |



| ITEM NO. | MAB-1632BK | MAB-1632DU | MAB-1632GD | MAB-1632GN | MAB-1632GY | MAB-1632PU |
|-----------------|---|-------------------------|-------------------|--------------------|-------------------|-------------------------|
| COLOR | Black Anodized 陽極黑 | Dark blue Anodized 陽極深藍 | Gold Anodized 陽極金 | Green Anodized 陽極綠 | Gray Anodized 陽極灰 | Pale blue Anodized 陽極淺藍 |
| | | | | | | |
| MATERIAL | Alloy / 鋁 | | | | | |
| SUITABLE STSTEM | M10 Adjust Suitable to Brake Lever / M10 剖溝螺絲 | | | | | |
| PACKAGE | 1000PCS/BAG | | | | | |

PARTS SERIES

BRAKE LEVER ADJUSTER

／ 剖溝螺絲 - 煞車把手用



| ITEM NO. | MAB-1632OG | MAB-1632PK | MAB-1632RD | MAB-1632SR | MAB-1632FW |
|-----------------|---|-----------------------|---------------------|------------------------|----------------------------|
| COLOR | Oragen Anodized 陽極橘 | Pink Anodized 陽極粉紅 | Red Anodized 陽極紅 | Silver Anodized 陽極銀 | Fog white Anodized 陽極霧白 |
| MATERIAL | Alloy / 鋁 | | | | |
| SUITABLE STSTEM | M10 Adjust Suitable to Brake Lever / M10 剖溝螺絲 | | | | |
| PACKAGE | 1000PCS/BAG | | | | |

ANCHOR BOLTS

／ 線止螺絲



| ITEM NO. | OAB-140575 | OAB-640809 | OAB-440711 |
|-----------------|---|------------|------------|
| COLOR | Nickel Plated / 鍍鎳 | | |
| MATERIAL | Iron / 鐵 | | |
| SUITABLE STSTEM | M4 Anchor Bolt, Suit to 1.1~1.8mm brake & shifting inner cable M4 線止螺絲，適用於 1.1~1.8mm 煞車 & 變速內線 | | |
| PACKAGE | 2000PCS/BAG | | |



| ITEM NO. | OAB-550814 | OAB-550715 | BMA-6313SR |
|-----------------|---|---|--|
| COLOR | Nickel Plated Black / 鍍鎳黑 | | Argon Plated / 鍍鉍 |
| MATERIAL | Iron / 鐵 ; Brass / 銅 | | Iron / 鐵 |
| SUITABLE STSTEM | M4 Anchor Bolt, Suit to 1.1~1.8mm brake & shifting inner cable M4 線止螺絲，適用於 1.1~1.8mm 變速 & 煞車內線 | Screws with Loctite to decrease the rish of shedding. 在螺牙上有點上耐落劑，可降低脫落風險 | M6 Anchor Bolt Suit to flexible to inner cable M6 控制線尾螺絲，適用於固定內線上 |
| PACKAGE | 2000PCS/BAG | | |

FIXING BOLT & SHOOK / 煞車外管轉接端套



| ITEM NO. | BMA-5710SR | BMA-5914SR |
|-----------------|-------------------------------|------------|
| COLOR | Nickel Plated / 鍍鎳 | |
| | | |
| MATERIAL | Iron / 鐵 | |
| SUITABLE STSTEM | Suit to Brake System / 煞車系統適用 | |
| PACKAGE | 5000PCS/BAG | |



| ITEM NO. | BMA-5712SR | BMA-0202BK | BMA-1105SR |
|-----------------|--|---------------------------------|------------------------|
| COLOR | Silver / 鋁本色 | Black / 黑色 | Argon Plated / 鍍鋅 |
| | | | |
| MATERIAL | Alloy / 鋁 | Plastic / 塑膠 | Iron / 鐵 |
| SUITABLE STSTEM | Suit to Brake System (Triple Layer) 煞車系統適用 (三層) | S Housing Converged S 型導管集線器 | Fixing Bolt 煞車系統固定栓 |
| PACKAGE | 5000PCS/BAG | 1000PCS/BAG | 2000PCS/BAG |

SHIFT PARTS / 內變速連結器



| ITEM NO. | BMA-0025SR | BMA-0232SR | BMA-0125SR |
|-----------------|---|------------|------------|
| COLOR | Nickel Plated / 鍍鎳 | | |
| | | | |
| MATERIAL | Iron / 鐵 ; Brass / 銅 | | |
| SUITABLE STSTEM | Thread Linker Suitable to Shifting cable / 內變速連結器 | | |
| PACKAGE | 500PCS/BAG | | |



AFTERMARKET



CABLE SET

CLASSIC

/ Derailleur Cable Set

(Compatible With SRAM/SHIMANO/CAMPAGNOLO System)



適用於 **SRAM/SHIMANO/CAMPAGNOLO** 變速系統



AVAILABLE COLOR 選配顏色

| ITEN NO. | COLOR | ITEN NO. | COLOR | ITEN NO. | COLOR |
|----------|--------------------|-----------|---------------------|-----------|-----------------------|
| CLS001BK | Black 黑色 | CLS0010PS | Pearl Silver 珍珠銀 | CLS0019YW | Yellow 黃色 |
| CLS002WH | White 白色 | CLS0011BN | Brown 咖啡色 | CLS0020PH | Peach 桃紅色 |
| CLS003GY | SHIMANO Gray 灰色 | CLS0012GE | Grape 葡萄色 | CLS0021OV | Oilve 深綠色 |
| CLS004RD | Red 紅色 | CLS0013EH | Earth 土色 | CLS0022SB | Sky Blue 天空藍 |
| CLS005BU | Blue 藍色 | CLS0014PE | Purple 紫色 | CLS0023PB | Purplish Blue 深紫藍色 |
| CLS006GN | Green 綠色 | CLS0015LB | Lake Blue 湖水藍 | CLS0024CO | Cappuccino 卡布奇諾 |
| CLS007PK | Pink 粉紅色 | CLS0016GG | Grass Green 草綠色 | CLS0025GD | Gold 金色 |
| CLS008OG | Orange 橘色 | CLS0017LP | Light Pink 粉紅色 | CLS0026SR | Silver 銀 |
| CLS009YW | Yellow 黃色 | CLS0018OE | Orange 亮橘色 | | |

COMPATIBLE PARTS 搭配零件

| DESCRIPTION | PARTS LIST | QTY |
|---|--|-----|
| CSH-S 4mm Cable Housing,Lubricated CSH-S 4mm 外管，注油 2500mm |  | 1 |
| SST ϕ 1.1mm Nipples:4.4x4.4/3.9x5 F:1600mm ϕ 1.1mm 光滑白鐵內線 鋅頭 :4.4x4.4/3.9x5 前變 :1600mm |  | 1 |
| SST ϕ 1.1mm Nipples:4.4x4.4/3.9x5 R:2300mm ϕ 1.1mm 光滑白鐵內線 鋅頭 :4.4x4.4/3.9x5 後變 :2300mm |  | 1 |
| OAC-43165BK Alloy End Cap,Water Proof,Anodized Black 鋁端套，防水型，陽極黑 |  | 8 |
| OAC-43165-10BK Alloy End Cap,Lor Friction,Anodized Black 鋁端套，低摩擦型，陽極黑 |  | 2 |
| IOR-1211BO O-ring,Octagonal Shape,Black O 型環，八角型，黑色 |  | 2 |
| FP-1245BK Frame Protector,Black 車架保護套，黑色 |  | 2 |
| BMA-2110BK End Tip,Anodized,Black 線尾套，陽極黑 |  | 2 |
| BMA-05186BK Rotating Hook,Black 集線勾，黑色 |  | 2 |

CLASSIC

Brake Cable Set

(Compatible With SRAM/SHIMANO System)

適用於 **SRAM/SHIMANO** 煞車系統

- ◆ Please contact Mars One if inner cable is required to fit CAMPAGNOLO system.
- ◆ 如需選配適用 CAMPAGNOLO 系統的產品，請另行告知 Mars One



AVAILABLE COLOR 選配顏色

| ITEN NO. | COLOR | ITEN NO. | COLOR | ITEN NO. | COLOR |
|----------|--------------------|-----------|---------------------|-----------|-----------------------|
| CLB001BK | Black 黑色 | CLB0010PS | Pearl Silver 珍珠銀 | CLB0019YW | Yellow 黃色 |
| CLB002WH | White 白色 | CLB0011BN | Brown 咖啡色 | CLB0020PH | Peach 桃紅色 |
| CLB003GY | SHIMANO Gray 灰色 | CLB0012GE | Grape 葡萄色 | CLB0021OV | Oilve 深綠色 |
| CLB004RD | Red 紅色 | CLB0013EH | Earth 土色 | CLB0022SB | Sky Blue 天空藍 |
| CLB005BU | Blue 藍色 | CLB0014PE | Purple 紫色 | CLB0023PB | Purplish Blue 深紫藍色 |
| CLB006GN | Green 綠色 | CLB0015LB | Lake Blue 湖水藍 | CLB0024CO | Cappuccino 卡布奇諾 |
| CLB007PK | Pink 粉紅色 | CLB0016GG | Grass Green 草綠色 | CLB0025GD | Gold 金色 |
| CLB008OG | Orange 橘色 | CLB0017LP | Light Pink 粉紅色 | CLB0026SR | Silver 銀 |
| CLB009YW | Yellow 黃色 | CLB0018OE | Orange 亮橘色 | | |

COMPATIBLE PARTS 搭配零件

| DESCRIPTION | PARTS LIST | QTY |
|---|------------|-----|
| CPH-S 5mm Cable Housing,Lubricated CPH-S 5mm 外管，注油 3000mm | | 1 |
| SST ϕ 1.5mm Nipples:7x6/6x11 F:1400mm ϕ 1.5mm 光滑白鐵內線 鋅頭 :7x6/6x11 前煞 :1400mm | | 1 |
| SST ϕ 1.5mm Nipples: 7x6/6x11 R:2400mm ϕ 1.5mm 光滑白鐵內線 鋅頭 : 7x6/6x11 後煞 :2400mm | | 1 |
| OAC-51155BK Alloy End Cap, Anodized Black 鋁端套，陽極黑 | | 6 |
| OAC-51165-10BK Alloy End Cap,Lor Friction,Anodized Black 鋁端套，低摩擦型，陽極黑 | | 2 |
| IOR-1610BO O-ring,Octagonal Shape,Black O 型環，八角型，黑色 | | 2 |
| FP-1245RD Frame Protector,Red 車架保護套，紅色 | | 2 |
| BMA-2211BK End Tip,Anodized,Black 線尾套，陽極黑 | | 2 |
| BMA-05186BK Rotating Hook,Black 集線勾，黑色 | | 2 |

CABLE SET

DAZZLE

/ Derailleur Cable Set

(Compatible With SRAM/SHIMANO/CAMPAGNOLO System)
適用於 SRAM/SHIMANO/CAMPAGNOLO 變速系統



AVAILABLE COLOR 選配顏色

| ITEM NO. | COLOR | |
|----------|----------------------|--|
| DAS001BK | Braided Black / 編織黑 | |
| DAS002SR | Braided Silver / 編織銀 | |
| DAS003GD | Braided Gold / 編織金 | |

COMPATIBLE PARTS 搭配零件

| DESCRIPTION | PARTS LIST | QTY |
|---|------------|-----|
| BSH-S 4.5mm Braided Cable Housing,Lubricated BSH-S 4.5mm 編織外管，注油 2500mm | | 1 |
| SST-LB ϕ 1.1mm Nipples:4.4x4.4/3.9x5 F:1600mm ϕ 1.1mm 低摩擦研磨白鐵內線 鋅頭 :4.4x4.4/3.9x5 前變 :1600mm | | 1 |
| SST-LB ϕ 1.1mm Nipples:4.4x4.4/3.9x5 R:2300mm ϕ 1.1mm 低摩擦研磨白鐵內線 鋅頭 :4.4x4.4/3.9x5 後變 :2300mm | SST-LB | 1 |
| OAC-46165BK Alloy End Cap,Water Proof,Anodized Black 鋁端套，防水型，陽極黑 | | 6 |
| OAC-46165-35BK Alloy End Cap,Dust Proof,Anodized Black 鋁端套，鼠尾防塵型，陽極黑 | | 2 |
| IOR-1211BO O-ring,Octagonal Shape,Black O 型環，八角型，黑色 | | 2 |
| FP-1245BK Frame Protector,Black 車架保護套，黑色 | | 2 |
| BMA-2110BK End Tip,Anodized,Black 線尾套，陽極黑 | | 2 |
| BMA-05186BK Rotating Hook,Black 集線勾，黑色 | | 2 |
| BMA-3115RD End Tip Protector,Red 線尾保護套，紅色 | | 2 |

DAZZLE

Brake Cable Set

(Compatible With SRAM/SHIMANO System)

適用於 **SRAM/SHIMANO** 煞車系統

- ◆ Please contact Mars One if inner cable is required to fit CAMPAGNOLO system.
- ◆ 如需選配適用 CAMPAGNOLO 系統的產品，請另行告知 Mars One

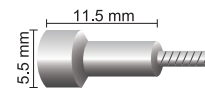









FOR MTB / ROAD

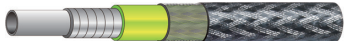
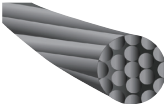
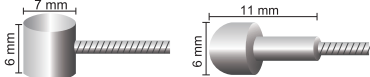

AVAILABLE COLOR 選配顏色

| ITEM NO. | COLOR | |
|----------|----------------------|---|
| DAB001BK | Braided Black / 編織黑 |  |
| DAB002SR | Braided Silver / 編織銀 |  |
| DAB003GD | Braided Gold / 編織金 |  |

COMPATIBLE PARTS 搭配零件

| DESCRIPTION | PARTS LIST | QTY |
|--|--|-----|
| BPH-S 5mm Braided Cable Housing, Lubricated BPH-S 5mm 編織外管，注油 3000mm |  | 1 |
| SST-LB ϕ 1.5mm Nipples: 7x6/6x11 F:1400mm ϕ 1.5mm 低摩擦研磨白鐵內線 鋅頭：7x6/6x11 前煞 1400mm |  | 1 |
| SST-LB ϕ 1.5mm Nipples: 7x6/6x11 R:2400mm ϕ 1.5mm 低摩擦研磨白鐵內線 鋅頭：7x6/6x11 後煞 2400mm |  SST-LB F:1400mm / R:2400mm | 1 |
| OAC-51155BK Alloy End Cap, Anodized Black 鋁端套，陽極黑 |  | 2 |
| OAC-51165-10BK Alloy End Cap, Low Friction, Anodized Black 鋁端套，低摩擦型，陽極黑 |  | 6 |
| IOR-1610BO O-ring, Octagonal Shape, Black O型環，八角型，黑色 |  | 2 |
| FP-1245RD Frame Protector, Red 車架保護套，紅色 |  | 2 |
| BMA-2211BK End Tip, Anodized, Black 線尾套，陽極黑 |  | 2 |
| BMA-05186BK Rotating Hook, Black 集線勾，黑色 |  | 2 |
| BMA-3115RD End Tip Protector, Red 線尾保護套，紅色 |  | 2 |

CABLE SET

SPEEDY

/ Derailleur Cable Set

(Compatible With SRAM/SHIMANO/CAMPAGNOLO System)

適用於 **SRAM/SHIMANO/CAMPAGNOLO** 變速系統









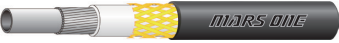
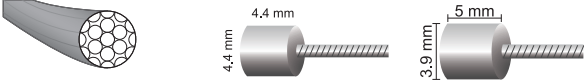
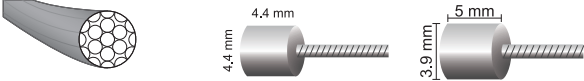

AVAILABLE COLOR 選配顏色

| ITEN NO. | COLOR |
|-----------|----------------------|
| SPS001BK | Kevlar Black / 克維拉黑 |
| SPS002WH | Kevlar White / 克維拉白 |
| SPS003GY | Kevlar Gray / 克維拉灰 |
| SPS004RD | Kevlar Red / 克維拉紅 |
| SPS005BU | Kevlar Blue / 克維拉藍 |
| SPS006GN | Kevlar Green / 克維拉綠 |
| SPS007PK | Kevlar Pink / 克維拉粉紅 |
| SPS008OG | Kevlar Orange / 克維拉橘 |
| SPS009YW | Kevlar Yellow / 克維拉黃 |
| SPS0010SR | Kevlar Silver / 克維拉銀 |

| ITEN NO. | COLOR |
|------------|--------------------------------|
| SPS0011FG | Fluorescent Green / 螢光綠 |
| SPS0012FY | Fluorescent Yellow / 螢光黃 |
| SPS0013FD | Fluorescent Red / 螢光紅 |
| SPS0014FO | Fluorescent Orange / 螢光橘 |
| SPS0015FDB | Fluorescent Dark Blue / 螢光深藍 |
| SPS0016CLB | Fluorescent Light Blue / 螢光淺藍 |
| SPS0017FLG | Fluorescent Light Green / 螢光淺綠 |

COMPATIBLE PARTS 搭配零件

| DESCRIPTION | PARTS LIST | QTY |
|---|--|-----|
| KSH-S 4mm Kevlar Cable Housing, Lubricated KSH-S 4mm 克維拉外管, 注油 2500mm |  | 1 |
| SPT ϕ 1.1mm Nipples: 4.4x4.4/3.9x5 F:1600mm ϕ 1.1mm 高潤滑白鐵內線 鉗頭: 4.4x4.4/3.9x5 前變: 1600mm |  | 1 |
| SPT ϕ 1.1mm Nipples: 4.4x4.4/3.9x5 R:2300mm ϕ 1.1mm 高潤滑白鐵內線 鉗頭: 4.4x4.4/3.9x5 後變: 2300mm |  | 1 |
| OAC-43135BK Alloy End Cap, Anodized Black 鋁端套, 陽極黑 |  | 6 |
| OAC-43165-35BK Alloy End Cap, Dust Proof, Anodized Black 鋁端套, 鼠尾防塵型, 陽極黑 |  | 4 |
| IOR-1211BO O-ring, Octagonal Shape, Black O型環, 八角型, 黑色 |  | 2 |
| FP-1245BK Frame Protector, Black 車架保護套, 黑色 |  | 2 |
| BMA-2110BK End Tip, Anodized, Black 線尾套, 陽極黑 |  | 2 |
| BMA-05186BK Rotating Hook, Black 集線勾, 黑色 |  | 2 |
| BMA-3115RD End Tip Protector, Red 線尾保護套, 紅色 |  | 2 |

SPEEDY

Brake Cable Set

(Compatible With SRAM/SHIMANO System)

適用於 **SRAM/SHIMANO** 煞車系統

- ◆ Please contact Mars One if inner cable is required to fit CAMPAGNOLO system.
- ◆ 如需選配適用 CAMPAGNOLO 系統的產品，請另行告知 Mars One

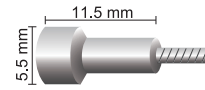

FOR MTB / ROAD



AVAILABLE COLOR 選配顏色

| ITEN NO. | COLOR |
|-----------|----------------------|
| SPB001BK | Kevlar Black / 克維拉黑 |
| SPB002WH | Kevlar White / 克維拉白 |
| SPB003GY | Kevlar Gray / 克維拉灰 |
| SPB004RD | Kevlar Red / 克維拉紅 |
| SPB005BU | Kevlar Blue / 克維拉藍 |
| SPB006GN | Kevlar Green / 克維拉綠 |
| SPB007PK | Kevlar Pink / 克維拉粉紅 |
| SPB008OG | Kevlar Orange / 克維拉橘 |
| SPB009YW | Kevlar Yellow / 克維拉黃 |
| SPB0010SR | Kevlar Silver / 克維拉銀 |

| ITEN NO. | COLOR |
|------------|--------------------------------|
| SPB0011FG | Fluorescent Green / 螢光綠 |
| SPB0012FY | Fluorescent Yellow / 螢光黃 |
| SPB0013FD | Fluorescent Red / 螢光紅 |
| SPB0014FO | Fluorescent Orange / 螢光橘 |
| SPB0015FDB | Fluorescent Dark Blue / 螢光深藍 |
| SPB0016CLB | Fluorescent Light Blue / 螢光淺藍 |
| SPB0017FLG | Fluorescent Light Green / 螢光淺綠 |

COMPATIBLE PARTS 搭配零件

| DESCRIPTION | PARTS LIST | QTY |
|---|-----------------------------|-----|
| KBH-S 5mm Kevlar Cable Housing, Lubricated KBH-S 5mm 克維拉外管，注油 3000mm | | 1 |
| SPT ϕ 1.5mm Nipples: 7x6/6x11 F:1400mm ϕ 1.5mm 高潤滑白鐵內線 鉗頭：7x6/6x11 前煞 1400mm | | 1 |
| SPT ϕ 1.5mm Nipples: 7x6/6x11 R:2400mm ϕ 1.5mm 高潤滑白鐵內線 鉗頭：7x6/6x11 後煞 2400mm | SPT F:1400mm / R:2400mm | 1 |
| OAC-51155BK Alloy End Cap, Anodized Black 鋁端套，陽極黑 | | 4 |
| OAC-51165-10BK Alloy End Cap, Low Friction, Anodized Black 鋁端套，低摩擦型，陽極黑 | | 6 |
| IOR-1610BO O-ring, Octagonal Shape, Black O 型環，八角型，黑色 | | 2 |
| FP-1245RD Frame Protector, Red 車架保護套，紅色 | | 2 |
| BMA-2211BK End Tip, Anodized, Black 線尾套，陽極黑 | | 2 |
| BMA-05186BK Rotating Hook, Black 集線勾，黑色 | | 2 |
| BMA-3115RD End Tip Protector, Red 線尾保護套，紅色 | | 2 |

CABLE SET

ZIPPER BAG

Derailleur Cable Set

(Compatible With SRAM/SHIMANO/CAMPAGNOLO System)





適用於 **SRAM/SHIMANO/CAMPAGNOLO** 變速系統

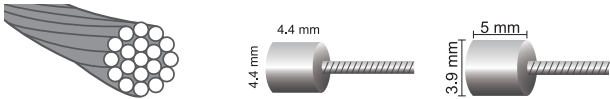
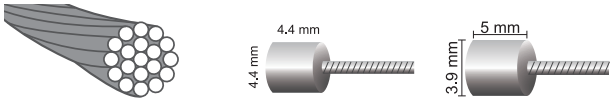

AVAILABLE COLOR 選配顏色

| ITEN NO. | COLOR | ITEN NO. | COLOR | ITEN NO. | COLOR |
|-----------|--------------------|------------|---------------------|------------|-----------------------|
| CSH001-ZB | Black 黑色 | CSH0010-ZB | Pearl Silver 珍珠銀 | CSH0019-ZB | Yellow 黃色 |
| CSH002-ZB | White 白色 | CSH0011-ZB | Brown 咖啡色 | CSH0020-ZB | Peach 桃紅色 |
| CSH003-ZB | SHIMANO Gray 灰色 | CSH0012-ZB | Grape 葡萄色 | CSH0021-ZB | Oilve 深綠色 |
| CSH004-ZB | Red 紅色 | CSH0013-ZB | Earth 土色 | CSH0022-ZB | Sky Blue 天空藍 |
| CSH005-ZB | Blue 藍色 | CSH0014-ZB | Purple 紫色 | CSH0023-ZB | Purplish Blue 深紫藍色 |
| CSH006-ZB | Green 綠色 | CSH0015-ZB | Lake Blue 湖水藍 | CSH0024-ZB | Cappuccino 卡布奇諾 |
| CSH007-ZB | Pink 粉紅色 | CSH0016-ZB | Grass Green 草綠色 | CSH0025-ZB | Gold 金色 |
| CSH008-ZB | Orange 橘色 | CSH0017-ZB | Light Pink 粉紅色 | CSH0026-ZB | Silver 銀 |
| CSH009-ZB | Yellow 黃色 | CSH0018-ZB | Orange 亮橘色 | | |

COMPATIBLE PARTS 搭配零件

| DESCRIPTION | PARTS LIST | QTY |
|--|--|-----|
| CSH-S 4mm Cable Housing, Lubricated CSH-S 4mm 外管, 注油 2500mm |  | 1 |
| RGA ϕ 1.2mm Nipples: 4.4x4.4/3.9x5 F:1600mm ϕ 1.2mm 鍍鋅內線 鋅頭 : 4.4x4.4/3.9x5 前變 : 1600mm |  | 1 |
| RGA ϕ 1.2mm Nipples: 4.4x4.4/3.9x5 R:2300mm ϕ 1.2mm 鍍鋅內線 鋅頭 : 4.4x4.4/3.9x5 後變 2300mm |  | 1 |
| OPC-4218BK Plastic End Cap, Black 塑膠端套, 黑色 |  | 10 |
| IOR-1211BO O-ring, Octagonal Shape, Black O型環, 八角型, 黑色 |  | 2 |
| FP-1245BK Frame Protector, Black 車架保護套, 黑色 |  | 2 |
| BMA-2110BK End Tip, Anodized, Black 線尾套, 陽極黑 |  | 2 |

ZIPPER BAG / Brake Cable Set

(Compatible With SRAM/SHIMANO System)

適用於 **SRAM/SHIMANO** 煞車系統

- ◆ Please contact Mars One if inner cable is required to fit CAMPAGNOLO system.
- ◆ 如需選配適用 CAMPAGNOLO 系統的產品，請另行告知 Mars One

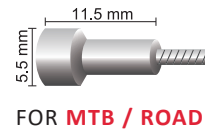

FOR MTB / ROAD



AVAILABLE COLOR 選配顏色

| ITEN NO. | COLOR | ITEN NO. | COLOR | ITEN NO. | COLOR |
|-----------|--------------------|------------|---------------------|------------|-----------------------|
| CSH001-ZB | Black 黑色 | CSH0010-ZB | Pearl Silver 珍珠銀 | CSH0019-ZB | Yellow 黃色 |
| CSH002-ZB | White 白色 | CSH0011-ZB | Brown 咖啡色 | CSH0020-ZB | Peach 桃紅色 |
| CSH003-ZB | SHIMANO Gray 灰色 | CSH0012-ZB | Grape 葡萄色 | CSH0021-ZB | Oilve 深綠色 |
| CSH004-ZB | Red 紅色 | CSH0013-ZB | Earth 土色 | CSH0022-ZB | Sky Blue 天空藍 |
| CSH005-ZB | Blue 藍色 | CSH0014-ZB | Purple 紫色 | CSH0023-ZB | Purplish Blue 深紫藍色 |
| CSH006-ZB | Green 綠色 | CSH0015-ZB | Lake Blue 湖水藍 | CSH0024-ZB | Cappuccino 卡布奇諾 |
| CSH007-ZB | Pink 粉紅色 | CSH0016-ZB | Grass Green 草綠色 | CSH0025-ZB | Gold 金色 |
| CSH008-ZB | Orange 橘色 | CSH0017-ZB | Light Pink 粉紅色 | CSH0026-ZB | Silver 銀 |
| CSH009-ZB | Yellow 黃色 | CSH0018-ZB | Orange 亮橘色 | | |

COMPATIBLE PARTS 搭配零件

| DESCRIPTION | PARTS LIST | QTY |
|--|-------------------------|-----|
| CPH-S 5mm Cable Housing, Lubricated CPH-S 5mm 外管，注油 3000mm | | 1 |
| RGA ø1.5mm Nipples: 7x6/6x11 F:1400mm ø1.5mm 鍍鋅內線 鋅頭: 7x6/6x11 前煞 :1400mm | | 1 |
| RGA ø1.5mm Nipples: 7x6/6x11 R:2400mm ø1.5mm 鍍鋅內線 鋅頭: 7x6/6x11 後煞 :2400mm | F:1400mm / R:2400mm | 1 |
| OBC-5111BK Brass End Cap, Black 銅端套，黑色 | | 10 |
| IOR-1610BO O-ring, Octagonal Shape, Black O型環，八角型，黑色 | | 2 |
| FP-1245RD Frame Protector, Red 車架保護套，紅色 | | 2 |
| BMA-2211BK End Tip, Anodized, Black 線尾套，陽極黑 | | 2 |

HYDRAULIC SET

1 Wheel

單輪份



AVAILABLE COLOR 選配顏色

| ITEM NO. | COLOR |
|----------|------------|
| HK01 | Black / 黑色 |
| HK02 | White / 白色 |
| HK03 | Red / 紅色 |
| HK04 | Blue / 藍色 |
| HK05 | Green / 綠色 |

| ITEM NO. | COLOR |
|----------|--------------------------|
| HK06 | Pink / 粉紅色 |
| HK07 | Orange / 橘色 |
| HK09 | Yellow / 黃色 |
| HS01 | Transparent Black / 透明黑 |
| HS02 | Transparent Silver / 透明銀 |

| ITEM NO. | AVAILABLE MODELS | STRUCTURE | SPEC | QTY |
|----------|------------------|-----------|------|-----|
|----------|------------------|-----------|------|-----|



FUS001

SHIMANO:

XTR 2007~2010
DEORE XT 2008~2011
DEORE 2005~2011
SLX 2009~2011
DEORE LX 2005~2011
HONE M535
XTR M975
DEROE T615,M595,M535,M525
ALiViO M4050
DEORE M6000,M596,M615
DEORE LX T675

SRAM:

JUJCY 3
CODE COD 2008~2010,5,7R,
2001,2017
GUILD RE

HAYES:

STROKER RYDE
STROKER DYNO
JUJCY 3
CODE COD 2008~2010,5,7R,
2001,2017
GUILD RE

HAYES:

STROKER RYDE
STROKER DYNO

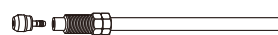

Hydraulic Hose
油壓管 1800mm

1



Compression Nut
SUS 外牙螺帽

2



Needle (Inserts)
D.I.Y 銅套油針

2



Plastic Cap
橡膠保護套

1



Allen Key
2mm 六角板手

1

| ITEM NO. | AVAILABLE MODELS | STRUCTURE | SPEC | QTY |
|----------|------------------|-----------|------|-----|
|----------|------------------|-----------|------|-----|



FUS002

HOPE:

BANJO
MINI
TRIAL
TECHX2
MOTOM6
MONO6T1
R DYNO



Hydraulic Hose
油壓管 1800mm

1



Compression Nut
SUS 外牙螺帽

2



Needle (Inserts)
D.I.Y 銅套油針

2



Calipers Shim
銅質油封
6.0*9.0*1.0mm

3



Banjo End
SUS 通用葫蘆螺帽

1



Banjo End
SUS 油管 M6 直接頭
螺帽外六角 10mm

1











Plastic Cap
橡膠保護套









1











Allen Key
2mm 六角板手

1

| ITEM NO. | AVAILABLE MODELS | STRUCTURE | SPEC | QTY |
|---|--|--|--|-----|
| <p>FUS003</p>  | <p>MAGURA: GLARA 2000~2002, LOUILS FR 2002~2006 GUSTAR 2000~2011, MARTA FR 2003~2010, JULIE HP 2009~2010, MARTA 2002~2010, LOUILS BAT 2008~2010, MARTA GOLD 2007, LOUILS CARBOM 2008~2010, MARTA SL 2003~2010, LOUILS 2000~2010</p> |  | Hydraulic Hose 油壓管 1800mm | 1 |
| | |  | Compression Nut SUS 外牙螺帽 | 2 |
| | |  | Needle (Inserts) D.I.Y 銅套油針 | 2 |
| | |  | Calipers Shim 銅質油封 6.0*9.0*1.0mm | 1 |
| | |  | Banjo End SUS 油管 M6 直接頭 螺帽外六角 10mm | 1 |
| | |  | Plastic Cap 橡膠保護套 | 1 |
| | |  | Allen Key 2mm 六角板手 | 1 |

| ITEM NO. | AVAILABLE MODELS | STRUCTURE | SPEC | QTY |
|---|--|--|--|-----|
| <p>FUS004</p>  | <p>SRAM: GUIDE RSC(A1), GUIDE RS(A1) ELIXIR CR, ELIXIR CR MAGNESIUM, ELIXIR R, ELIXIR 9, ELIXIR 7, ELIXIR 5, X0,X7,X9</p> |  | Hydraulic Hose 油壓管 1800mm | 1 |
| | |  | Banjo End SUS 通用葫蘆螺 | 1 |
| | |  | Compression Nut SUS 外牙螺帽 | 2 |
| | |  | Needle (Inserts) D.I.Y 銅套油針 | 2 |
| | |  | Calipers Shim 銅質油封 6.0*9.0*1.0mm | 2 |
| | |  | Plastic Cap 橡膠保護套 | 1 |
| | |  | Allen Key 2mm 六角板手 | 1 |

| ITEM NO. | AVAILABLE MODELS | STRUCTURE | SPEC | QTY |
|---|---|--|--|-----|
| <p>FUS005</p>  | <p>FORMULA: ORO</p> <p>SHIMANO: XTR 2005~2006</p> |  | Hydraulic Hose 油壓管 1800mm | 1 |
| | |  | Banjo End SUS 通用葫蘆螺 | 2 |
| | |  | Compression Nut SUS 外牙螺帽 | 2 |
| | |  | Needle (Inserts) D.I.Y 銅套油針 | 2 |
| | |  | Calipers Shim 銅質油封 6.0*9.0*1.0mm | 4 |
| | |  | Plastic Cap 橡膠保護套 | 1 |
| | |  | Allen Key 2mm 六角板手 | 1 |

HYDRAULIC SET

2 Wheel / 雙輪份



AVAILABLE COLOR 選配顏色

| ITEM NO. | COLOR | ITEM NO. | COLOR |
|----------|------------|----------|--------------------------|
| HK01 | Black / 黑色 | HK06 | Pink / 粉紅色 |
| HK02 | White / 白色 | HK07 | Orange / 橘色 |
| HK03 | Red / 紅色 | HK09 | Yellow / 黃色 |
| HK04 | Blue / 藍色 | HS01 | Transparent Black / 透明黑 |
| HK05 | Green / 綠色 | HS02 | Transparent Silver / 透明銀 |

| ITEM NO. | AVAILABLE MODELS | STRUCTURE | SPEC | QTY |
|----------|------------------|-----------|------|-----|
|----------|------------------|-----------|------|-----|

FUD001



SHIMANO:

XTR 2007~2010
 DEORE XT 2008~2011
 DEORE 2005~2011
 SLX 2009~2011
 DEORE LX 2005~2011
 HONE M535
 XTR M975
 DEROE T615, M595, M535, M525
 ALIVIO M4050
 DEORE M6000, M596, M615
 DEORE LX T675

SRAM:

JUICY 3
 CODE COD 2008~2010, 5, 7R,
 2001, 2017
 GUILD RE

HAYES:

STROKER RYDE
 STROKER DYNO

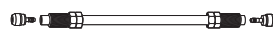

Hydraulic Hose
油壓管 3000mm

1



Compression Nut
SUS 外牙螺帽

4



Needle (Inserts)
D.I.Y 銅套油針

4



Plastic Cap
橡膠保護套

2



Allen Key
2mm 六角板手

1

FUD002



HOPE:

BANJO
 MINI
 TRIAL
 TECHX2
 MOTOM6
 MONO6T1



Hydraulic Hose
油壓管 3000mm

1



Compression Nut
SUS 外牙螺帽

4



Needle (Inserts)
D.I.Y 銅套油針

4



Calipers Shim
銅質油封
6.0*9.0*1.0mm

6



Banjo End
SUS 通用葫蘆螺帽

2

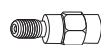

Banjo End
SUS 油管 M6 直接頭
螺帽外六角 10mm

2











Plastic Cap
橡膠保護套







2



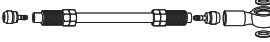



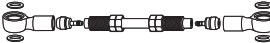

Allen Key
2mm 六角板手

1

| ITEM NO. | AVAILABLE MODELS | STRUCTURE | SPEC | QTY |
|---|--|--|--|-----|
| <p>FUD003</p>  | <p>MAGURA: GLARA 2000~2002, LOUILS FR 2002~2006 GUSTAR 2000~2011, MARTA FR 2003~2010, JULIE HP 2009~2010, MARTA 2002~2010, LOUILS BAT 2008~2010, MARTA GOLD 2007, LOUILS CARBOM 2008~2010, MARTA SL 2003~2010, LOUILS 2000~2010</p> |  | Hydraulic Hose 油壓管 3000mm | 1 |
| | |  | Compression Nut SUS 外牙螺帽 | 4 |
| | |  | Needle (Inserts) D.I.Y 銅套油針 | 4 |
| | |  | Calipers Shim 銅質油封 6.0*9.0*1.0mm | 2 |
| | |  | Banjo End SUS 油管 M6 直接頭 螺帽外六角 10mm | 2 |
| | |  | Plastic Cap 橡膠保護套 | 2 |
| | |  | Allen Key 2mm 六角板手 | 1 |

| ITEM NO. | AVAILABLE MODELS | STRUCTURE | SPEC | QTY |
|---|--|--|--|-----|
| <p>FUD004</p>  | <p>SRAM: GUIDE RSC(A1), GUIDE RS(A1) ELIXIR CR, ELIXIR CR MAGNESIUM, ELIXIR R, ELIXIR 9, ELIXIR 7, ELIXIR 5, X0,X7,X9</p> |  | Hydraulic Hose 油壓管 3000mm | 1 |
| | |  | Banjo End SUS 通用葫蘆螺 | 2 |
| | |  | Compression Nut SUS 外牙螺帽 | 4 |
| | |  | Needle (Inserts) D.I.Y 銅套油針 | 4 |
| | |  | Calipers Shim 銅質油封 6.0*9.0*1.0mm | 4 |
| | |  | Plastic Cap 橡膠保護套 | 2 |
| | |  | Allen Key 2mm 六角板手 | 1 |

| ITEM NO. | AVAILABLE MODELS | STRUCTURE | SPEC | QTY |
|---|---|--|--|-----|
| <p>FUD005</p>  | <p>FORMULA: ORO</p> <p>SHIMANO: XTR 2005~2006</p> |  | Hydraulic Hose 油壓管 3000mm | 1 |
| | |  | Banjo End SUS 通用葫蘆螺 | 4 |
| | |  | Compression Nut SUS 外牙螺帽 | 4 |
| | |  | Needle (Inserts) D.I.Y 銅套油針 | 4 |
| | |  | Calipers Shim 銅質油封 6.0*9.0*1.0mm | 8 |
| | |  | Plastic Cap 橡膠保護套 | 2 |
| | |  | Allen Key 2mm 六角板手 | 1 |

PET BLISTER

Package:PET Blister
Length:30M/ROLL
Attachment:Frame Protector x1

包裝方式 :PET 泡殼
長度 :30M/ 捲
附加物 : 車架保護套 x1























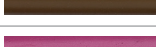

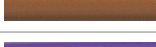
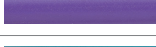
PRODUCT STRUCTURE

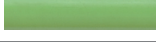

基本變速外管 :CSH-S 4mm, 管內注油
Basic Derailleur Housing: CSH-S 4mm,
Lubricated Liner

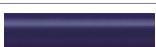

基本煞車外管 :CPH-S 5mm, 管內注油
Basic Brake Housing: CPH-S 5mm,
Lubricated Liner

| COLOR | ITEM NO. | ITEM NO. |
|---|-------------------------------------|-------------|
|  | Black / 黑色 CSH001S-30T | CPH001S-30T |
|  | White / 白色 CSH002S-30T | CPH002S-30T |
|  | SHIMANO Gray / 灰色 CSH003S-30T | CPH003S-30T |
|  | Red / 紅色 CSH004S-30T | CPH004S-30T |
|  | Blue / 藍色 CSH005S-30T | CPH005S-30T |
|  | Green / 綠色 CSH006S-30T | CPH006S-30T |
|  | Pink / 粉紅色 CSH007S-30T | CPH007S-30T |
|  | Orange / 橘色 CSH008S-30T | CPH008S-30T |
|  | Yellow / 黃色 CSH009S-30T | CPH009S-30T |
|  | Pearl Silver / 珍珠銀 CSH010S-30T | CPH010S-30T |
|  | Brown / 咖啡色 CSH011S-30T | CPH011S-30T |
|  | Grape / 萄色 CSH012S-30T | CPH012S-30T |
|  | Earth / 土色 CSH013S-30T | CPH013S-30T |
|  | Purple / 紫色 CSH014S-30T | CPH014S-30T |
|  | Lake Blue / 湖水藍 CSH015S-30T | CPH015S-30T |
|  | Grass Green / 草綠色 CSH016S-30T | CPH016S-30T |
|  | Light Pink / 粉紅色 CSH017S-30T | CPH017S-30T |
|  | Orange / 亮橘色 CSH018S-30T | CPH018S-30T |
|  | Yellow / 黃色 CSH019S-30T | CPH019S-30T |
|  | Peach / 桃紅色 CSH020S-30T | CPH020S-30T |
|  | Olive / 深綠色 CSH021S-30T | CPH021S-30T |
|  | Sky Blue / 天空藍 CSH022S-30T | CPH022S-30T |
|  | Purplish Blue / 深紫藍色 CSH023S-30T | CPH023S-30T |
|  | Cappuccino / 卡布奇諾 CSH024S-30T | CPH024S-30T |
|  | Gold / 金色 CSH025S-30T | CPH025S-30T |
|  | Silver / 銀 CSH026S-30T | CPH026S-30T |

Package:PET Blister
 Length:30M/ROLL
 Attachment:Frame Protector x1

包裝方式 :PET 泡殼
 長度 :30M/ 捲
 附加物 : 車架保護套 x1



PRODUCT STRUCTURE



基本變速外管 :CSH-S 4mm, 管內注油
 Basic Derailleur Housing: CSH-S 4mm,
 Lubricated Liner



基本煞車外管 :CPH-S 5mm, 管內注油
 Basic Brake Housing: CPH-S 5mm,
 Lubricated Liner

| COLOR | ITEM NO. | ITEM NO. |
|--|---------------|---------------|
|  Fluorescent Green / 螢光綠 | CSHFCH001-30T | FPHFCH001-30T |
|  Fluorescent Yellow / 螢光黃 | CSHFCH002-30T | FPHFCH002-30T |
|  Fluorescent Red / 螢光紅 | CSHFCH003-30T | FPHFCH003-30T |
|  Fluorescent Orange / 螢光橘 | CSHFCH004-30T | FPHFCH004-30T |
|  Fluorescent Pink / 螢光粉紅 | CSHFCH005-30T | FPHFCH005-30T |
|  Fluorescent Dark Blue / 螢光深藍 | CSHFCH007-30T | FPHFCH007-30T |
|  Fluorescent Light Blue / 螢光淺藍 | CSHFCH008-30T | FPHFCH008-30T |
|  Fluorescent Light Green / 螢光淺綠 | CSHFCH009-30T | FPHFCH009-30T |
|  Black / 消光黑 | CSHMBK-30T | CPHMBK-30T |
|  Gray / 消光灰 | CSHMGY-30T | CPHMGY-30T |
|  Red / 消光紅 | CSHMRD-30T | CPHMRD-30T |
|  Brown / 消光咖啡 | CSHMBR-30T | CPHMBR-30T |
|  Blue / 消光藍 | CSHMBU-30T | CPHMBU-30T |



PRODUCT STRUCTURE



變速編織外管 : BSH-S 4.5mm, 管內注油
 Derailleur Braided Housing:
 BSH-S 4.5mm,Lubricated Liner



煞車編織外管 : BPH-S 5mm, 管內注油
 Brake Braided Housing:
 BPH-S 5mm,Lubricated Liner

| COLOR | ITEM NO. | ITEM NO. |
|--|-------------|-------------|
|  Braided Black / 編織黑 | BSH001S-30T | BPH001S-30T |
|  Braided Silver / 編織銀 | BSH002S-30T | BPH002S-30T |
|  Braided Gold / 編織金 | BSH003S-30T | BPH003S-30T |

PET BLISTER

Package:PET Blister
 Length:30M/ROLL
 Attachment:Frame Protector x1

包裝方式 :PET 泡殼
 長度 :30M/ 捲
 附加物 : 車架保護套 x1



PRODUCT STRUCTURE

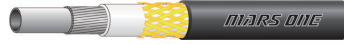

變速克維拉外管 : KSH-S 4mm, 管內注油
 Derailleur Kevlar Housing:
 KSH-S 4mm,Lubricated Liner

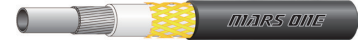

煞車克維拉外管 : KBH-S 5mm, 管內注油
 Brake Kevlar Housing:
 KBH-S 5mm,Lubricated Liner

| COLOR | ITEM NO. | ITEM NO. |
|--|-------------|-------------|
|  Kevlar Black / 克維拉黑 | KSH001S-30T | KBH001S-30T |
|  Kevlar White / 克維拉白 | KSH002S-30T | KBH002S-30T |
|  Kevlar Gray / 克維拉灰 | KSH003S-30T | KBH003S-30T |
|  Kevlar Red / 克維拉紅 | KSH004S-30T | KBH004S-30T |
|  Kevlar Blue / 克維拉藍 | KSH005S-30T | KBH005S-30T |
|  Kevlar Green / 克維拉綠 | KSH006S-30T | KBH006S-30T |
|  Kevlar Pink / 克維拉粉紅 | KSH007S-30T | KBH007S-30T |
|  Kevlar Orange / 克維拉橘 | KSH008S-30T | KBH008S-30T |
|  Kevlar Yellow / 克維拉黃 | KSH009S-30T | KBH009S-30T |
|  Kevlar Silver / 克維拉銀 | KSH010S-30T | KBH010S-30T |
|  Fluorescent Green / 螢光綠 | KSH011S-30T | KBH011S-30T |
|  Fluorescent Yellow / 螢光黃 | KSH012S-30T | KBH012S-30T |
|  Fluorescent Red / 螢光紅 | KSH013S-30T | KBH013S-30T |
|  Fluorescent Orange / 螢光橘 | KSH014S-30T | KBH014S-30T |
|  Fluorescent Dark Blue / 螢光深藍 | KSH015S-30T | KBH015S-30T |
|  Fluorescent Light Blue / 螢光淺藍 | KSH016S-30T | KBH016S-30T |
|  Fluorescent Light Green / 螢光淺綠 | KSH017S-30T | KBH017S-30T |

Package:PET Blister
 Length:30M/ROLL
 Attachment:Frame Protector x1

包裝方式 :PET 泡殼
 長度 :30M/ 捲
 附加物 : 車架保護套 x1









PRODUCT STRUCTURE

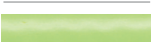

HKN

SHIMANO、FORMULA ID:2.3 xOD:5.0
 SRAM、MAGULA ID:2.1 xOD:5.0
 HAYES、TEKTRO ID:2.5 xOD:5.4

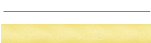
| COLOR | ITEAM NO. |
|--|-----------|
|  Black / 黑色 | HKN01-30T |
|  White / 白色 | HKN02-30T |
|  Red / 紅色 | HKN03-30T |
|  Blue / 藍色 | HKN04-30T |
|  Green / 綠色 | HKN05-30T |
|  Pink / 粉紅色 | HKN06-30T |
|  Orange / 橘色 | HKN07-30T |
|  Yellow / 黃色 | HKN08-30T |

PRODUCT STRUCTURE



HSN

SHIMANO、FORMULA ID:2.3 xOD:5.0
 SRAM、MAGULA ID:2.1 xOD:5.0
 HAYES、TEKTRO ID:2.5 xOD:5.4

| COLOR | ITEAM NO. |
|--|-----------|
|  Transparent Black / 透明黑 | HSN01-30T |
|  Transparent Silver / 透明銀 | HSN02-30T |

BOX

Package:BOX
Length:50M/ROLL

包裝方式:彩盒裝
長度:50M/捲



PRODUCT STRUCTURE



基本變速外管 :CSH-S 4mm, 管內注油
Basic Derailleur Housing: CSH-S 4mm,
Lubricated Liner



基本煞車外管 :CPH-S 5mm, 管內注油
Basic Brake Housing: CPH-S 5mm,
Lubricated Liner

| COLOR | | ITEM NO. | ITEM NO. |
|-------|----------------------|-------------|-------------|
| | Black / 黑色 | CSH001-50X | CPH001-50X |
| | White / 白色 | CSH002-50X | CPH002-50X |
| | SHIMANO Gray / 灰色 | CSH003-50X | CPH003-50X |
| | Red / 紅色 | CSH004-50X | CPH004-50X |
| | Blue / 藍色 | CSH005-50X | CPH005-50X |
| | Green / 綠色 | CSH006-50X | CPH006-50X |
| | Pink / 粉紅色 | CSH007-50X | CPH007-50X |
| | Orange / 橘色 | CSH008-50X | CPH008-50X |
| | Yellow / 黃色 | CSH009-50X | CPH009-50X |
| | Pearl Silver / 珍珠銀 | CSH0010-50X | CPH0010-50X |
| | Brown / 咖啡色 | CSH011-50X | CPH011-50X |
| | Grape / 萄色 | CSH012-50X | CPH012-50X |
| | Earth / 土色 | CSH013-50X | CPH013-50X |
| | Purple / 紫色 | CSH014-50X | CPH014-50X |
| | Lake Blue / 湖水藍 | CSH015-50X | CPH015-50X |
| | Grass Green / 草綠色 | CSH016-50X | CPH016-50X |
| | Light Pink / 粉紅色 | CSH017-50X | CPH017-50X |
| | Orange / 亮橘色 | CSH018-50X | CPH018-50X |
| | Yellow / 黃色 | CSH019-50X | CPH019-50X |
| | Peach / 桃紅色 | CSH020-50X | CPH020-50X |
| | Olive / 深綠色 | CSH021-50X | CPH021-50X |
| | Sky Blue / 天空藍 | CSH022-50X | CPH022-50X |
| | Purplish Blue / 深紫藍色 | CSH023-50X | CPH023-50X |
| | Cappuccino / 卡布奇諾 | CSH024-50X | CPH024-50X |
| | Gold / 金色 | CSH025-50X | CPH025-50X |
| | Silver / 銀 | CSH026-50X | CPH026-50X |

Package:BOX
Length:50M/ROLL

包裝方式:彩盒裝
長度:50M/捲



PRODUCT STRUCTURE



基本變速外管 :CSH-S 4mm, 管內注油
Basic Derailleur Housing: CSH-S 4mm,
Lubricated Liner



基本煞車外管 :CPH-S 5mm, 管內注油
Basic Brake Housing: CPH-S 5mm,
Lubricated Liner

| COLOR | ITEAM NO. | ITEAM NO. |
|--------------------------------|---------------|---------------|
| Fluorescent Green / 螢光綠 | CSHFCH001-50X | FPHFCH001-50X |
| Fluorescent Yellow / 螢光黃 | CSHFCH002-50X | FPHFCH002-50X |
| Fluorescent Red / 螢光紅 | CSHFCH003-50X | FPHFCH003-50X |
| Fluorescent Orange / 螢光橘 | CSHFCH004-50X | FPHFCH004-50X |
| Fluorescent Pink / 螢光粉紅 | CSHFCH005-50X | FPHFCH005-50X |
| Fluorescent Dark Blue / 螢光深藍 | CSHFCH007-50X | FPHFCH007-50X |
| Fluorescent Light Blue / 螢光淺藍 | CSHFCH008-50X | FPHFCH008-50X |
| Fluorescent Light Green / 螢光淺綠 | CSHFCH009-50X | FPHFCH009-50X |
| Black / 消光黑 | CSHMBK-50X | CPHMBK-50X |
| Gray / 消光灰 | CSHMGY-50X | CPHMGY-50X |
| Red / 消光紅 | CSHMRD-50X | CPHMRD-50X |
| Brown / 消光咖啡 | CSHMBR-50X | CPHMBR-50X |
| Blue / 消光藍 | CSHMBU-50X | CPHMBU-50X |

PRODUCT STRUCTURE



變速編織外管 : BSH-S 4.5mm, 管內注油
Derailleur Braided Housing:
BSH-S 4.5mm,Lubricated Liner



煞車編織外管 : BPH-S 5mm, 管內注油
Brake Braided Housing:
BPH-S 5mm,Lubricated Liner

| COLOR | ITEAM NO. | ITEAM NO. |
|----------------------|------------|------------|
| Braided Black / 編織黑 | BSH001-50X | BPH001-50X |
| Braided Silver / 編織銀 | BSH002-50X | BPH002-50X |
| Braided Gold / 編織金 | BSH003-50X | BPH003-50X |

BOX

Package:BOX
Length:50M/ROLL

包裝方式:彩盒裝
長度:50M/捲



PRODUCT STRUCTURE

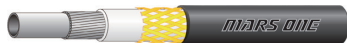

變速克維拉外管: KSH-S 4mm, 管內注油
Derailleur Kevlar Housing:
KSH-S 4mm,Lubricated Liner



煞車克維拉外管: KBH-S 5mm, 管內注油
Brake Kevlar Housing:
KBH-S 5mm,Lubricated Liner

| COLOR | ITEAM NO. | ITEAM NO. |
|--|------------|------------|
|  Kevlar Black / 克維拉黑 | KSH001-50X | KBH001-50X |
|  Kevlar White / 克維拉白 | KSH002-50X | KBH002-50X |
|  Kevlar Gray / 克維拉灰 | KSH003-50X | KBH003-50X |
|  Kevlar Red / 克維拉紅 | KSH004-50X | KBH004-50X |
|  Kevlar Blue / 克維拉藍 | KSH005-50X | KBH005-50X |
|  Kevlar Green / 克維拉綠 | KSH006-50X | KBH006-50X |
|  Kevlar Pink / 克維拉粉紅 | KSH007-50X | KBH007-50X |
|  Kevlar Orange / 克維拉橘 | KSH008-50X | KBH008-50X |
|  Kevlar Yellow / 克維拉黃 | KSH009-50X | KBH009-50X |
|  Kevlar Silver / 克維拉銀 | KSH010-50X | KBH010-50X |
|  Fluorescent Green / 螢光綠 | KSH011-50X | KBH011-50X |
|  Fluorescent Yellow / 螢光黃 | KSH012-50X | KBH012-50X |
|  Fluorescent Red / 螢光紅 | KSH013-50X | KBH013-50X |
|  Fluorescent Orange / 螢光橘 | KSH014-50X | KBH014-50X |
|  Fluorescent Dark Blue / 螢光深藍 | KSH015-50X | KBH015-50X |
|  Fluorescent Light Blue / 螢光淺藍 | KSH016-50X | KBH016-50X |
|  Fluorescent Light Green / 螢光淺綠 | KSH017-50X | KBH017-50X |

Package:BOX
Length:50M/ROLL

包裝方式:彩盒裝
長度:50M/捲









**PRODUCT
STRUCTURE**

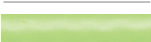

HKN

SHIMANO、FORMULA ID:2.3 xOD:5.0
SRAM、MAGULA ID:2.1 xOD:5.0
HAYES、TEKTRO ID:2.5 xOD:5.4

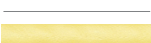
| COLOR | ITEAM NO. |
|--|-----------|
|  Black / 黑色 | HKN01-50X |
|  White / 白色 | HKN02-50X |
|  Red / 紅色 | HKN03-50X |
|  Blue / 藍色 | HKN04-50X |
|  Green / 綠色 | HKN05-50X |
|  Pink / 粉紅色 | HKN06-50X |
|  Orange / 橘色 | HKN07-50X |
|  Yellow / 黃色 | HKN08-50X |

**PRODUCT
STRUCTURE**



HSN

SHIMANO、FORMULA ID:2.3 xOD:5.0
SRAM、MAGULA ID:2.1 xOD:5.0
HAYES、TEKTRO ID:2.5 xOD:5.4

| COLOR | ITEAM NO. |
|--|-----------|
|  Transparent Black / 透明黑 | HSN01-50X |
|  Transparent Silver / 透明銀 | HSN02-50X |

LUBE

Package: CARD
Length: 3M











PRODUCT STRUCTURE

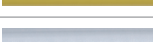

基本變速外管 :CSH-S 4mm, 管內注油
Basic Derailleur Housing: CSH-S 4mm,
Lubricated Liner

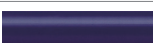

基本煞車外管 :CPH-S 5mm, 管內注油
Basic Brake Housing: CPH-S 5mm,
Lubricated Liner

| COLOR | ITEM NO. | ITEM NO. |
|---|---------------------------------|----------|
|  | Black / 黑色 LUS4001 | LUB5001 |
|  | White / 白色 LUS4002 | LUB5002 |
|  | SHIMANO Gray / 灰色 LUS4003 | LUB5003 |
|  | Red / 紅色 LUS4004 | LUB5004 |
|  | Blue / 藍色 LUS4005 | LUB5005 |
|  | Green / 綠色 LUS4006 | LUB5006 |
|  | Pink / 粉紅色 LUS4007 | LUB5007 |
|  | Orange / 橘色 LUS4008 | LUB5008 |
|  | Yellow / 黃色 LUS4009 | LUB5009 |
|  | Pearl Silver / 珍珠銀 LUS4010 | LUB5010 |
|  | Brown / 咖啡色 LUS4011 | LUB5011 |
|  | Grape / 萄色 LUS4012 | LUB5012 |
|  | Earth / 土色 LUS4013 | LUB5013 |
|  | Purple / 紫色 LUS4014 | LUB5014 |
|  | Lake Blue / 湖水藍 LUS4015 | LUB5015 |
|  | Grass Green / 草綠色 LUS4016 | LUB5016 |
|  | Light Pink / 粉紅色 LUS4017 | LUB5017 |
|  | Orange / 亮橘色 LUS4018 | LUB5018 |
|  | Yellow / 黃色 LUS4019 | LUB5019 |
|  | Peach / 桃紅色 LUS4020 | LUB5020 |
|  | Olive / 深綠色 LUS4021 | LUB5022 |
|  | Sky Blue / 天空藍 LUS4022 | LUB5023 |
|  | Purplish Blue / 深紫藍色 LUS4023 | LUB5024 |
|  | Cappuccino / 卡布奇諾 LUS4024 | LUB5025 |
|  | Gold / 金色 LUS4025 | LUB5026 |
|  | Silver / 銀 LUS4026 | LUB5027 |

Package: CARD
Length: 3M



PRODUCT STRUCTURE



基本變速外管 :CSH-S 4mm, 管內注油
Basic Derailleur Housing: CSH-S 4mm,
Lubricated Liner



基本煞車外管 :CPH-S 5mm, 管內注油
Basic Brake Housing: CPH-S 5mm,
Lubricated Liner

| COLOR | ITEAM NO. | ITEAM NO. |
|--------------------------------|------------|------------|
| Fluorescent Green / 螢光綠 | LUS4FCH001 | LUB5FCH001 |
| Fluorescent Yellow / 螢光黃 | LUS4FCH002 | LUB5FCH002 |
| Fluorescent Red / 螢光紅 | LUS4FCH003 | LUB5FCH003 |
| Fluorescent Orange / 螢光橘 | LUS4FCH004 | LUB5FCH004 |
| Fluorescent Pink / 螢光粉紅 | LUS4FCH006 | LUB5FCH006 |
| Fluorescent Dark Blue / 螢光深藍 | LUS4FCH007 | LUB5FCH007 |
| Fluorescent Light Blue / 螢光淺藍 | LUS4FCH008 | LUB5FCH008 |
| Fluorescent Light Green / 螢光淺綠 | LUS4FCH009 | LUB5FCH009 |
| Black / 消光黑 | LUS4MBK | LUB5MBK |
| Gray / 消光灰 | LUS4MGY | LUB5MGY |
| Red / 消光紅 | LUS4MRD | LUB5MRD |
| Brown / 消光咖啡 | LUS4MBR | LUB5MBR |
| Blue / 消光藍 | LUS4MBU | LUB5MBU |

PRODUCT STRUCTURE



變速編織外管 : BSH-S 4.5mm, 管內注油
Derailleur Braided Housing:
BSH-S 4.5mm,Lubricated Liner



煞車編織外管 : BPH-S 5mm, 管內注油
Brake Braided Housing:
BPH-S 5mm,Lubricated Liner

| COLOR | COLOR | COLOR |
|----------------------|---------|---------|
| Braided Black / 編織黑 | LUBS001 | LUBB001 |
| Braided Silver / 編織銀 | LUBS002 | LUBB002 |
| Braided Gold / 編織金 | LUBS003 | LUBB003 |

LUBE

Package: CARD
Length: 3M



PRODUCT STRUCTURE



變速克維拉外管 : KSH-S 4mm, 管內注油
Derailleur Kevlar Housing:
KSH-S 4mm,Lubricated Liner

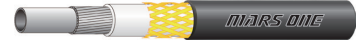

煞車克維拉外管 : KBH-S 5mm, 管內注油
Brake Kevlar Housing:
KBH-S 5mm,Lubricated Liner

| COLOR | ITEAM NO. | ITEAM NO. |
|--|-----------|-----------|
|  Kevlar Black / 克維拉黑 | LUKS001 | LUKB001 |
|  Kevlar White / 克維拉白 | LUKS002 | LUKB002 |
|  Kevlar Gray / 克維拉灰 | LUKS003 | LUKB003 |
|  Kevlar Red / 克維拉紅 | LUKS004 | LUKB004 |
|  Kevlar Blue / 克維拉藍 | LUKS005 | LUKB005 |
|  Kevlar Green / 克維拉綠 | LUKS006 | LUKB006 |
|  Kevlar Pink / 克維拉粉紅 | LUKS007 | LUKB007 |
|  Kevlar Orange / 克維拉橘 | LUKS008 | LUKB008 |
|  Kevlar Yellow / 克維拉黃 | LUKS009 | LUKB009 |
|  Kevlar Silver / 克維拉銀 | LUKS010 | LUKB010 |
|  Fluorescent Green / 螢光綠 | LUKS011 | LUKB011 |
|  Fluorescent Yellow / 螢光黃 | LUKS012 | LUKB012 |
|  Fluorescent Red / 螢光紅 | LUKS013 | LUKB013 |
|  Fluorescent Orange / 螢光橘 | LUKS014 | LUKB014 |
|  Fluorescent Dark Blue / 螢光深藍 | LUKS015 | LUKB015 |
|  Fluorescent Light Blue / 螢光淺藍 | LUKS016 | LUKB016 |
|  Fluorescent Light Green / 螢光淺綠 | LUKS017 | LUKB017 |



**PRODUCT
STRUCTURE**







HKN

SHIMANO、FORMULA ID:2.3 xOD:5.0
 SRAM、MAGULA ID:2.1 xOD:5.0
 HAYES、TEKTRO ID:2.5 xOD:5.4

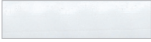
/ 單輪 1.8M /

/ 雙輪 3M /

| COLOR | ITEAM NO. | ITEAM NO. |
|---|-----------|-----------|
|  Black / 黑色 | LUHKN01-1 | LUHKN01-2 |
|  White / 白色 | LUHKN02-1 | LUHKN02-2 |
|  Red / 紅色 | LUHKN03-1 | LUHKN03-2 |
|  Blue / 藍色 | LUHKN04-1 | LUHKN04-2 |
|  Green / 綠色 | LUHKN05-1 | LUHKN05-2 |
|  Pink / 粉紅色 | LUHKN06-1 | LUHKN06-2 |
|  Orange / 橘色 | LUHKN07-1 | LUHKN07-2 |
|  Yellow / 黃色 | LUHKN08-1 | LUHKN08-2 |

**PRODUCT
STRUCTURE**



HSN

SHIMANO、FORMULA ID:2.3 xOD:5.0
 SRAM、MAGULA ID:2.1 xOD:5.0
 HAYES、TEKTRO ID:2.5 xOD:5.4

/ 單輪 1.8M /

/ 雙輪 3M /

| COLOR | ITEAM NO. | ITEAM NO. |
|--|-----------|-----------|
|  Transparent Black / 透明黑 | LUHSN01-1 | LUHSN01-2 |
|  Transparent Silver / 透明銀 | LUHSN02-1 | LUHSN02-2 |

SHIFTER INNER CABLE

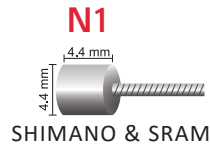

| ITEM NO. | | DESCRIPTION | COMPATIBLE SYSTEM | LENGTH | QTY |
|----------------|---|---|-------------------|--------|--------|
| 2RGA22001-1X |  RGA | 1.2mm Regular Galvanized 1.2mm 鍍鋅內線 | N1 S&S | 2200mm | 100PCS |
| 2RGA22002-1X | | | N2 Campy | | |
| 2RST22001-1X |  RST | 1.2mm Regular Stainless 1.2mm 白鐵內線 | N1 S&S | 2200mm | 100PCS |
| 2RST22002-1X | | | N2 Campy | | |
| 1SGA22001-1X |  SGA | 1.1mm Slick Galvanized 1.1mm 研磨鍍鋅內線 | N1 S&S | 2200mm | 100PCS |
| 1SGA22002-1X | | | N2 Campy | | |
| 1SST22001-1X |  SST | 1.1mm Slick Stainless 1.1mm 研磨白鐵內線 | N1 S&S | 2200mm | 100PCS |
| 1SST22002-1X | | | N2 Campy | | |
| 1SGALB22001-1X |  SGA-LB | 1.1mm Slick Galvanized Low Friction 1.1mm 低摩擦研磨鍍鋅內線 | N1 S&S | 2200mm | 100PCS |
| 1SGALB22002-1X | | | N2 Campy | | |
| 1SSTLB22001-1X |  SST-LB | 1.1mm Slick Stainless Low Friction 1.1mm 低摩擦研磨白鐵內線 | N1 S&S | 2200mm | 100PCS |
| 1SSTLB22002-1X | | | N2 Campy | | |
| 1TSS22001-1X |  TSS | 1.1mm TEFLON Slick Stainless 1.1mm 鐵氟龍研磨白鐵 | N1 S&S | 2200mm | 100PCS |
| 1TSS22002-1X | | | N2 Campy | | |
| 1SPT22001-1X |  SPT | 1.1mm SPT Slick Stainless 1.1mm 高潤滑白鐵內線 | N1 S&S | 2200mm | 100PCS |
| 1SPT22002-1X | | | N2 Campy | | |



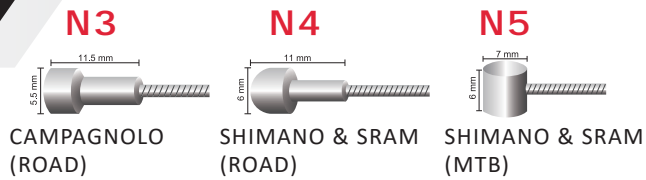

BRAKE INNER CABLE

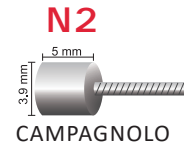
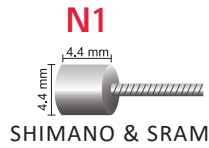

| ITEM NO. | | DESCRIPTION | COMPATIBLE SYSTEM | LENGTH | QTY |
|----------------|--|---|-------------------|--------|--------|
| 5RGA17003-1X | | 1.5mm Regular Galvanized 1.5mm 鍍鋅內線 | N3 Campy | 1700mm | 100PCS |
| 5RGA17004-1X | | | N4 Road | | |
| 5RGA17005-1X | | | N5 MTB | | |
| 5RST17003-1X | | 1.5mm Regular Stainless 1.5mm 白鐵內線 | N3 Campy | 1700mm | 100PCS |
| 5RST17004-1X | | | N4 Road | | |
| 5RST17005-1X | | | N5 MTB | | |
| 5SGA17003-1X | | 1.5mm Slick Galvanized 1.5mm 研磨鍍鋅內線 | N3 Campy | 1700mm | 100PCS |
| 5SGA17004-1X | | | N4 Road | | |
| 5SGA17005-1X | | | N5 MTB | | |
| 5SST17003-1X | | 1.5mm Slick Stainless 1.5mm 研磨白鐵內線 | N3 Campy | 1700mm | 100PCS |
| 5SST17004-1X | | | N4 Road | | |
| 5SST17005-1X | | | N5 MTB | | |
| 5SGALB17003-1X | | 1.5mm Slick Galvanized Low Friction 1.5mm 低摩擦研磨鍍鋅內線 | N3 Campy | 1700mm | 100PCS |
| 5SGALB17004-1X | | | N4 Road | | |
| 5SGALB17005-1X | | | N5 MTB | | |
| 5SSTLB17003-1X | | 1.5mm Slick Stainless Low Friction 1.5mm 低摩擦研磨白鐵內線 | N3 Campy | 1700mm | 100PCS |
| 5SSTLB17004-1X | | | N4 Road | | |
| 5SSTLB17005-1X | | | N5 MTB | | |
| 5TSS17003-1X | | 1.5mm TEFLON Slick Stainless 1.5mm 鐵氟龍研磨白鐵 | N3 Campy | 1700mm | 100PCS |
| 5TSS17004-1X | | | N4 Road | | |
| 5TSS17005-1X | | | N5 MTB | | |
| 5SPT17003-1X | | 1.5mm SPT Slick Stainless 1.5mm 高潤滑白鐵內線 | N3 Campy | 1700mm | 100PCS |
| 5SPT17004-1X | | | N4 Road | | |
| 5SPT17005-1X | | | N5 MTB | | |
| 5DSG17003-1X | | 1.5mm 7x7 Slick Galvanized 1.5mm 7x7 鍍鋅內線 | N3 Campy | 1700mm | 100PCS |
| 5DSG17004-1X | | | N4 Road | | |
| 5DSG17005-1X | | | N5 MTB | | |
| 5DST17003-1X | | 1.5mm 7x7 Slick Stainless 1.5mm 7x7 白鐵內線 | N3 Campy | 1700mm | 100PCS |
| 5DST17004-1X | | | N4 Road | | |
| 5DST17005-1X | | | N5 MTB | | |

SHIFTER INNER CABLE



| ITEM NO. | | DESCRIPTION | COMPATIBLE SYSTEM | LENGTH | QTY |
|--------------|---|--|-------------------|--------|--------------|
| S2RGA22001 |  RGA | 1.2mm Regular Galvanized | N1 S&S | 2200mm | 1PC/ CARD |
| S2RGA22002 | | 1.2mm 鍍鋅內線 | N2 Campy | | |
| S2RST22001 |  RST | 1.2mm Regular Stainless | N1 S&S | 2200mm | 1PC/ CARD |
| S2RST22002 | | 1.2mm 白鐵內線 | N2 Campy | | |
| S1SGA22001 |  SGA | 1.1mm Slick Galvanized | N1 S&S | 2200mm | 1PC/ CARD |
| S1SGA22002 | | 1.1mm 研磨鍍鋅內線 | N2 Campy | | |
| S1SST22001 |  SST | 1.1mm Slick Stainless | N1 S&S | 2200mm | 1PC/ CARD |
| S1SST22002 | | 1.1mm 研磨白鐵內線 | N2 Campy | | |
| S1SGALB22001 |  SGA-LB | 1.1mm Slick Galvanized Low Friction | N1 S&S | 2200mm | 1PC/ CARD |
| S1SGALB22002 | | 1.1mm 低摩擦研磨鍍鋅內線 | N2 Campy | | |
| S1SSTLB22001 |  SST-LB | 1.1mm Slick Stainless Low Friction | N1 S&S | 2200mm | 1PC/ CARD |
| S1SSTLB22002 | | 1.1mm 低摩擦研磨白鐵內線 | N2 Campy | | |
| S1TSS22001 |  TSS | 1.1mm TEFLON Slick Stainless | N1 S&S | 2200mm | 1PC/ CARD |
| S1TSS22002 | | 1.1mm 鐵氟龍研磨白鐵 | N2 Campy | | |
| S1SPT22001 |  SPT | 1.1mm SPT Slick Stainless | N1 S&S | 2200mm | 1PC/ CARD |
| S1SPT22002 | | 1.1mm 高潤滑白鐵內線 | N2 Campy | | |

BRAKE INNER CABLE

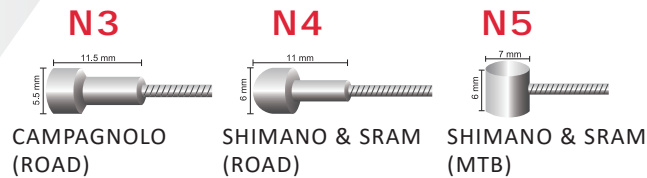

| ITEM NO. | DESCRIPTION | COMPATIBLE SYSTEM | LENGTH | QTY |
|--------------|--|-------------------|--------|--------------|
| S5RGA17003 |  RGA 1.5mm Regular Galvanized 1.5mm 鍍鋅內線 | N3 Campy | 1700mm | 1PC/ CARD |
| S5RGA17004 | | N4 Road | | |
| S5RGA17005 | | N5 MTB | | |
| S5RST17003 |  RST 1.5mm Regular Stainless 1.5mm 白鐵內線 | N3 Campy | 1700mm | 1PC/ CARD |
| S5RST17004 | | N4 Road | | |
| S5RST17005 | | N5 MTB | | |
| S5SGA17003 |  SGA 1.5mm Slick Galvanized 1.5mm 研磨鍍鋅內線 | N3 Campy | 1700mm | 1PC/ CARD |
| S5SGA17004 | | N4 Road | | |
| S5SGA17005 | | N5 MTB | | |
| S5SST17003 |  SST 1.5mm Slick Stainless 1.5mm 研磨白鐵內線 | N3 Campy | 1700mm | 1PC/ CARD |
| S5SST17004 | | N4 Road | | |
| S5SST17005 | | N5 MTB | | |
| S5SGALB17003 |  SGA-LB 1.5mm Slick Galvanized Low Friction 1.5mm 低摩擦研磨鍍鋅內線 | N3 Campy | 1700mm | 1PC/ CARD |
| S5SGALB17004 | | N4 Road | | |
| S5SGALB17005 | | N5 MTB | | |
| S5SSTLB17003 |  SST-LB 1.5mm Slick Stainless Low Friction 1.5mm 低摩擦研磨白鐵內線 | N3 Campy | 1700mm | 1PC/ CARD |
| S5SSTLB17004 | | N4 Road | | |
| S5SSTLB17005 | | N5 MTB | | |
| S5TSS17003 |  TSS 1.5mm TEFLON Slick Stainless 1.5mm 鐵氟龍研磨白鐵 | N3 Campy | 1700mm | 1PC/ CARD |
| S5TSS17004 | | N4 Road | | |
| S5TSS17005 | | N5 MTB | | |
| S5SPT17003 |  SPT 1.5mm SPT Slick Stainless 1.5mm 高潤滑白鐵內線 | N3 Campy | 1700mm | 1PC/ CARD |
| S5SPT17004 | | N4 Road | | |
| S5SPT17005 | | N5 MTB | | |
| S5DSG17003 |  DSG 1.5mm 7x7 Slick Galvanized 1.5mm 7x7 鍍鋅內線 | N3 Campy | 1700mm | 1PC/ CARD |
| S5DSG17004 | | N4 Road | | |
| S5DSG17005 | | N5 MTB | | |
| S5DST17003 |  DST 1.5mm 7x7 Slick Stainless 1.5mm 7x7 白鐵內線 | N3 Campy | 1700mm | 1PC/ CARD |
| S5DST17004 | | N4 Road | | |
| S5DST17005 | | N5 MTB | | |

BMX FREE STYLE

UPPER CABLE

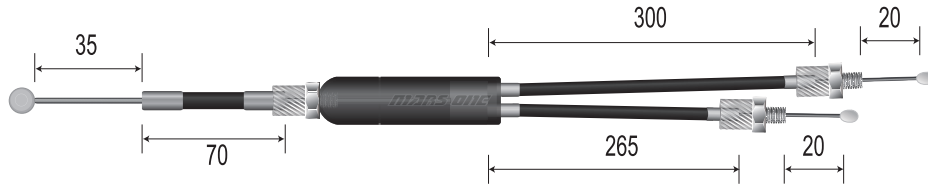

LOWER CABLE

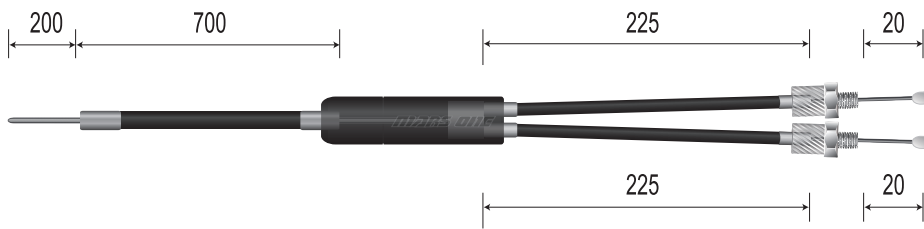

Part No: **BFS01**

STANDARD SPECIFICATION 標準規格

| ITEM NO. | SIZE | ROTOR |
|----------|--|--------|
| BXUL-25 | Upper:35,70,300,265,20 Lower:20,225,700,200 | 1" |
| BXUL-29 | Upper:35,70,300,265,20 Lower:20,225,700,200 | 1 1/8" |

BMX ROTOR



BRAKE SHOES

MARS ONE®



V-BRAKE

| ITEM NO. | BS-5572CH | BS-5572CHR | BS-9672V |
|-------------|--|--|---|
| | | | |
| DESCRIPTION | New groove design Length 長度：72m/m | 與 BS-5572CH 做替換用 Pad & Pins only Length 長度：72m/m | EN standard compound Length 長度：72m/m |
| ITEM NO. | BS-9472CH | BS-9472CHR | BS-9655CH |
| | | | |
| DESCRIPTION | Holder color silver, black,titanium,carbon 表面處理 Length 長度：72m/m | 與 BS-9472CH 做替換用 Length 長度：72m/m | For mini bikes and folding bikes. Length 長度：55mm |

R-BRAKE

| ITEM NO. | BS-4757R | BS-4755CH | BS-4755CHR |
|-------------|--|--|-------------------------------------|
| | | | |
| DESCRIPTION | Holder color titanium,black, red,orange | Compatible with all major roc Brakes iriple color | 與 BS-4755CH 做替換用 Length 長度：55m/m |

MTB-BRAKE

| ITEM NO. | BS-72 |
|-------------|--|
| | |
| DESCRIPTION | Holder color: 黑 Black、藍 Blue、紅 Red / Length 長度：72m/m |

BMX-BRAKE

| ITEM NO. | BS-6072V |
|-------------|---|
| | |
| DESCRIPTION | For BMX U-brake / Clear 藍 Blue、綠 Green、紫 Purple / Length 長度：72m/m |

DISK PADS



| ITEM NO. | DP001 | DP002 | DP003 | DP004 |
|-------------------|--|---------------------|---|------------------------------|
| | | | | |
| COMPETIBLE SYSTEM | SHIMANO: DEORE MECHANICAL TEKTRO: HYDRAULIC | AVID: JUICY3.5.7 | SHIMANO: XTR BR-M965/M966/ XT2004/SAINT | FORMULA: MEGA ONE,R,R1,RX |
| ITEM NO. | DP005 | DP006 | DP007 | |
| | | | | |
| COMPETIBLE SYSTEM | AVID:ELIXIR | SHIMANO:XTR2011 | HAYES STROKER RYDE,DYNO | |
| ITEM NO. | DP009 | DP010 | DP008 | DP006-1 |
| | | | | |
| COMPETIBLE SYSTEM | AVID BB5 | SRAM RED | MAGURA:MT2,4,6,8 | SHIMANO XTR |

HYDRAULIC HOUSING REPLACEMENT TOOL KIT

Item No: **TB-001**



HYDRAULIC CUTTER



Item No: **HYC-01**

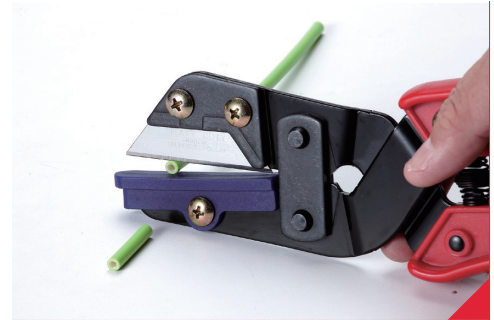

1. Only compatible for hydraulic hose, NOT for inner cable, Cable housings or other cables.

| ITEM NO. | |
|----------|--|
| HPN | |
| HKN | |
| HSN | |

2. The blade is inside

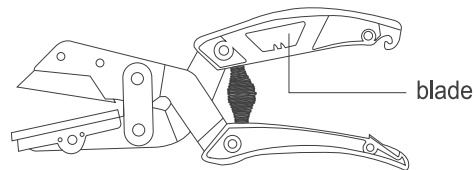

CABLE / HOUSING CUTTER

To cut inner cable and housings.





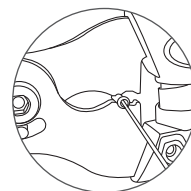
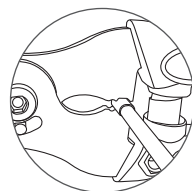
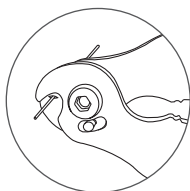
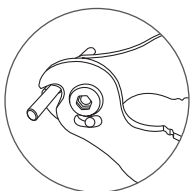















Item No: **CC01**



COMBO



| PART NO. | PART NAME | | QTY | |
|----------|---|----------------|---|------|
| CBS01 |  | OAC-43135BK | 4mm Alloy End Cap 4mm 鋁端套 | 10PC |
| |  | BMA-2110BK | End tip for shifter inner cable 變速線用線尾套 | 2PC |
| CBS02 |  | OAC-43165BK | 4mm Alloy End Cap w/Waterproof 4mm 防水型鋁端套 | 10PC |
| |  | BMA-2110BK | End tip for shifter inner cable 變速線用線尾套 | 2PC |
| CBS03 |  | OAC-43165-10BK | 4mm Alloy End Cap w/Low Friction 4mm 低摩擦型鋁端套 | 10PC |
| |  | BMA-2110BK | End tip for shifter inner cable 變速線用線尾套 | 2PC |
| CBS04 |  | OAC-43165-35BK | 4mm Alloy End Cap w/Anti-Dirt 4mm 防塵型鋁端套 | 10PC |
| |  | BMA-2110BK | End tip for shifter inner cable 變速線用線尾套 | 2PC |
| CBB01 |  | OAC-51155BK | 5mm Alloy End Cap 5mm 鋁端套 | 10PC |
| |  | BMA-2211BK | End tip for brake inner cable 煞車線用線尾套 | 2PC |
| CBB02 |  | OAC-51165BK | 5mm Alloy End Cap w/Waterproof 5mm 防水型鋁端套 | 10PC |
| |  | BMA-2211BK | End tip for brake inner cable 煞車線用線尾套 | 2PC |
| CBB03 |  | OAC-51165-10BK | 5mm Alloy End Cap w/Low Friction 5mm 低摩擦型鋁端套 | 10PC |
| |  | BMA-2211BK | End tip for brake inner cable 煞車線用線尾套 | 2PC |
| CBB04 |  | OAC-51165-19BK | 5mm Alloy End Cap w/Anti-Dirt 5mm 防塵型鋁端套 | 10PC |
| |  | BMA-2211BK | End tip for brake inner cable 煞車線用線尾套 | 2PC |
| CBB05 |  | OAC-51165-35BK | 5mm Alloy End Cap w/Anti-Dirt 5mm 防塵型鋁端套 | 10PC |
| |  | BMA-2211BK | End tip for brake inner cable 煞車線用線尾套 | 2PC |



| PART NO. | PART NAME | | QTY |
|----------|---|--|------|
| CBB06 |  | BMA-2211BK End tip for brake inner cable 煞車線用線尾套 | 10PC |
| CBFP01 |  | FP-1245BK Frame Protector 車架保護套 | 2PC |
| CBFP02 |  | FP-1245RD Frame Protector 車架保護套 | 2PC |
| CBFP03 |  | FP-0910BK Frame Protector 車架保護套 | 2PC |
| CBFP04 |  | FP-0910RD Frame Protector 車架保護套 | 2PC |
| CBFP05 |  | FP-0760BK Spiral Frame Protector 螺旋型車架保護套 | 4PC |
| CBAS01 |  | AJ1130M5BK M5 Adjust Screw M5 調整螺絲 | 2PC |
| CBAS02 |  | IL-6862GB Adjust Screw for shifter 變速調整螺絲 | 2PC |
| CBAS03 |  | AL-082843GB Adjust Screw for shifter / Duck type 定格變速調整螺絲 | 2PC |
| CBAS04 |  | AL-082851GB Adjust Screw for brake / Duck type 定格煞車調整螺絲 | 2PC |
| CBP01 |  | PVC-7016BK Presta Valve Cap 法式氣嘴蓋 | 2PC |
| CBS01 |  | SVC-1016BK Schrader Valve Cap 美式氣嘴蓋 | 2PC |
| CBMAB01 |  | MAB-1632BK M10 Brake Lever-Adjust Screw M10 剖溝螺絲 - 煞車把手適用 | 2PC |
| CBH01 |  | HCN-101252ST Suit to SHIMANO/FORMULA/AVID/ MAGURA;OD5.0mm Housing 適用 SHIMANO/FORMULA/AVID/ MAGURA;OD5.0mm 油管 | 2PC |
| CBH02 |  | HCN-101257ST Suit to HAYES/TEKTRO;OD5.4mm Housing 適用 HAYES/TEKTRO;OD5.4mm 油管 | 2PC |
| CBH03 |  | HBE-260830ST Suit to SHIMANO/FORMULA;ID2.3mm Housing 適用 SHIMANO/FORMULA;ID2.3mm 油管 | 2PC |
| |  | HOR090106BR | 4PC |

COMBO



| PART NO. | PART NAME | | QTY |
|----------|---|--|-----|
| CBH04 |  | HBE-240830ST Suit to AVID/MAGURA;ID2.1mm Housing 適用 AVID/MAGURA;ID2.1mm 油管 | 2PC |
| |  | HOR090106BR | 4PC |
| CBH05 |  | HBE-280830ST Suit to HAYES/TEKTRO;ID2.5mm Housing 適用 HAYES/TEKTRO;ID2.5mm 油管 | 2PC |
| |  | HOR090106BR | 4PC |
| CBH06 |  | HCS-081152ST Suit to SHIMANO/FORMULA/AVID/ MAGURA;OD5.0mm Housing 適用 SHIMANO/FORMULA/AVID/ MAGURA;OD5.0mm 油管 | 2PC |
| |  | HCS-081157ST Suit to HAYES/TEKTRO;OD5.4mm Housing 適用 HAYES/TEKTRO;OD5.4mm 油管 | 2PC |
| CBH08 |  | HBN-1032M6ST24 Suit to AVID/MAGURA;ID2.1mm Housing 適用 AVID/MAGURA;ID2.1mm 油管 | 2PC |
| |  | HOR090106BR | 2PC |
| CBH09 |  | HBN-1032M6ST28 Suit to HAYES/TEKTRO;ID2.5mm Housing 適用 HAYES/TEKTRO;ID2.5mm 油管 | 2PC |
| |  | HOR090106BR | 2PC |
| CBH10 |  | HCA-081652AL Suit to SHIMANO/FORMULA/AVID/ MAGURA;OD5.0mm Housing 適用 SHIMANO/FORMULA/AVID/ MAGURA;OD5.0mm 油管 | 2PC |
| CBH11 |  | HCA-081657AL Suit to HAYES/TEKTRO;OD5.4mm Housing 適用 HAYES/TEKTRO;OD5.4mm 油管 | 2PC |
| CBH12 |  | HIN-110526BR Suit to SHIMANO/FORMULA; ID2.3mm Housing 適用 SHIMANO/FORMULA; ID2.3mm 油管 | 4PC |
| CBH13 |  | HIN-110524BR Suit to AVID/MAGURA;ID2.1mm Housing 適用 AVID/MAGURA;ID2.1mm 油管 | 4PC |
| CBH14 |  | HIN-110528BR Suit to HAYES/TEKTRO;ID2.5mm Housing 適用 HAYES/TEKTRO;ID2.5mm 油管 | 4PC |
| CBH15 |  | HSS-1115M6ST Bango End M6x12mm 油管接頭螺絲 M6x12mm | 2PC |



MARS ONE

CABLE LOCK

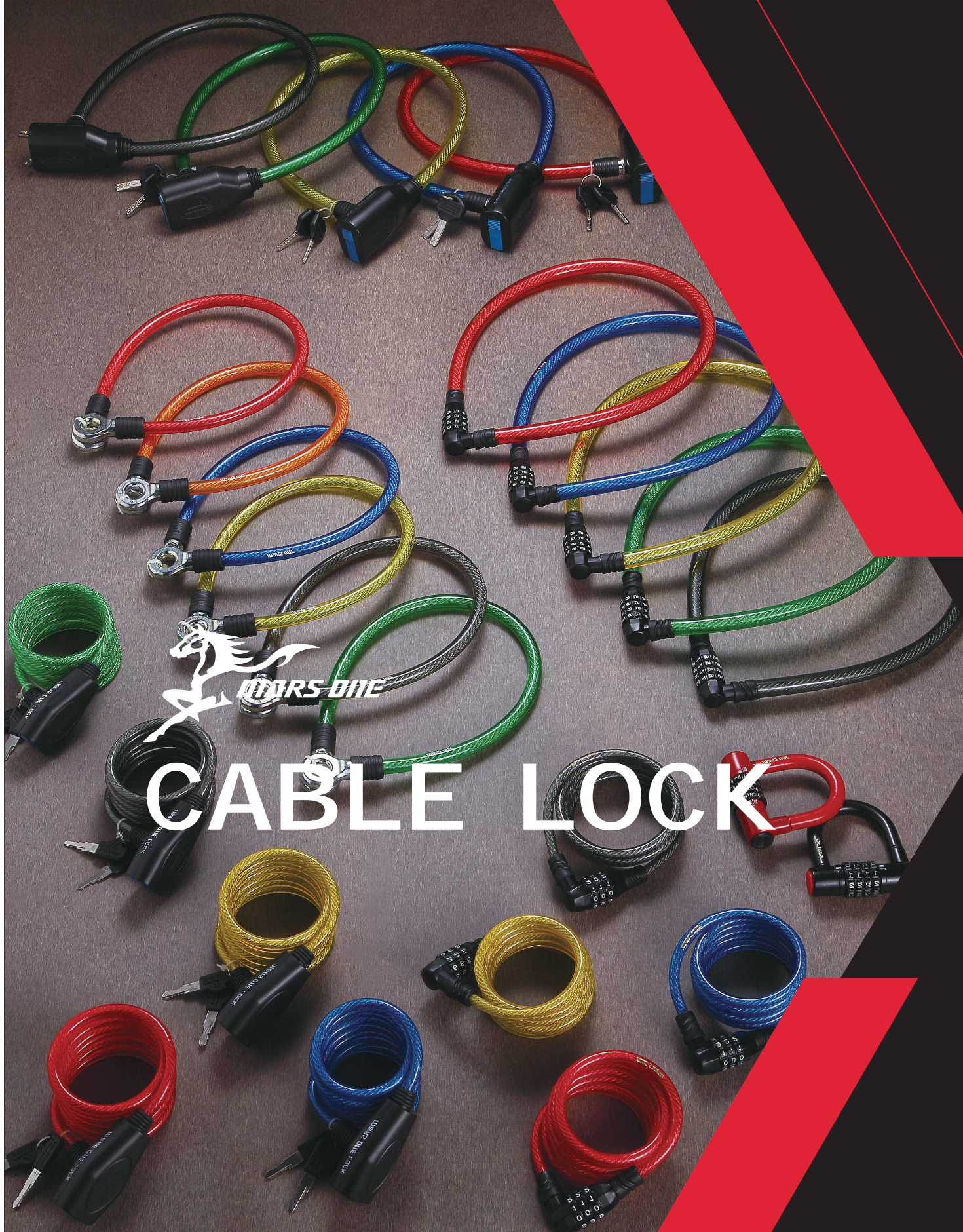

CABLE LOCK

SPIRAL CABLE LOCK / 卡巴捲線鎖



| ITEM NO. | CL40870TB | CL40870BU | CL40870GN | CL40870YW | CL40870RD |
|-----------|-------------------------|------------------------|-------------------------|--------------------------|-----------------------|
| COLOR | Tansparent Black 透明黑 | Tansparent Blue 透明藍 | Tansparent Green 透明綠 | Tansparent Yellow 透明黃 | Tansparent Red 透明紅 |
| I.D. | 4mm | | | | |
| O.D. | 8mm | | | | |
| LENGTH | 70" | | | | |
| ACCESSORY | W/2 Keys / 附鑰匙 2PCS | | | | |



| ITEM NO. | CL501531TB | CL501531BU | CL501531GN | CL501531YW | CL501531RD |
|-----------|-------------------------|------------------------|-------------------------|--------------------------|-----------------------|
| COLOR | Tansparent Black 透明黑 | Tansparent Blue 透明藍 | Tansparent Green 透明綠 | Tansparent Yellow 透明黃 | Tansparent Red 透明紅 |
| I.D. | 5mm | | | | |
| O.D. | 13mm | | | | |
| LENGTH | 31" | | | | |
| ACCESSORY | W/2 Keys / 附鑰匙 2PCS | | | | |

3 DIGIT RESETTABLE COMBINATION CABLE LOCK

3 段安全捲線密碼鎖



| ITEM NO. | RL40859TB | RL40859BU | RL40859GN | RL40859YW | RL40859RD |
|----------|-------------------------|------------------------|-------------------------|--------------------------|-----------------------|
| COLOR | Tansparent Black 透明黑 | Tansparent Blue 透明藍 | Tansparent Green 透明綠 | Tansparent Yellow 透明黃 | Tansparent Red 透明紅 |
| I.D. | 4mm | | | | |
| O.D. | 8mm | | | | |
| LENGTH | 59" | | | | |

4 DIGIT RESETTABLE COMBINATION CABLE LOCK

/ 4 段安全密碼鎖



| ITEM NO. | RL501531TB | RL501531BU | RL501531GN | RL501531YW | RL501531RD |
|----------|-------------------------|------------------------|-------------------------|--------------------------|-----------------------|
| COLOR | Tansparent Black 透明黑 | Tansparent Blue 透明藍 | Tansparent Green 透明綠 | Tansparent Yellow 透明黃 | Tansparent Red 透明紅 |
| I.D. | 5mm | | | | |
| O.D. | 15mm | | | | |
| LENGTH | 31" | | | | |

LOCK CABLE-LOOP

/ 多功能鋼索



| ITEM NO. | MC 5012TB | MC 5012BU | MC 5012GN | MC 5012YW | MC 5012RD | MC 5012TOG |
|----------|-------------------------|------------------------|-------------------------|--------------------------|-----------------------|--------------------------|
| COLOR | Tansparent Black 透明黑 | Tansparent Blue 透明藍 | Tansparent Green 透明綠 | Tansparent Yellow 透明黃 | Tansparent Red 透明紅 | Tansparent Orange 透明橘 |
| I.D. | 5mm | | | | | |
| O.D. | 12mm | | | | | |
| LENGTH | 24" 31" 39" | | | | | |



| ITEM NO. | MCOB 5012TB |
|----------|-------------------------|
| COLOR | Tansparent Black 透明黑 |
| I.D. | 5mm |
| O.D. | 15mm |
| LENGTH | 2M、4M、5M、7M、8M、10M |

CABLE LOCK

U-SHACKLE LOCK

單扣型鋼索鎖



| ITEM NO. | UL1216180GD | UL1216180SR | LOCK002BK | LOCK002RD |
|-----------|---------------------|--------------|-------------|-----------|
| COLOR | Gold 金色 | Silver 銀色 | Black 黑色 | Red 紅色 |
| I.D. | 12mm | | 10mm | |
| O.D. | 160mm | | 12mm | |
| LENGTH | 180" | | | |
| ACCESSORY | W/2 Keys / 附鑰匙 2PCS | | | |